

1814E with FilterQuick™

Electric Fryer

Installation, Operation and Maintenance Manual

This manual is updated as new information and models are released. Visit our website for the latest manual.



FOR YOUR SAFETY

Do Not Store or use gasoline or other flammable vapors and liquids in the vicinity of this or any other appliance.

 **CAUTION**

READ THE INSTRUCTIONS BEFORE USING THE FRYER.



8 1 9 7 3 1 7

Part Number: FRY_IOM_8197317 08/2016

Original Instructions

 **NOTICE**

IF, DURING THE WARRANTY PERIOD, THE CUSTOMER USES A PART FOR THIS MANITOWOC FOOD SERVICE EQUIPMENT OTHER THAN AN UNMODIFIED NEW OR RECYCLED PART PURCHASED DIRECTLY FROM FRYMASTER OR ANY OF ITS AUTHORIZED SERVICERS, AND/OR THE PART BEING USED IS MODIFIED FROM ITS ORIGINAL CONFIGURATION, THIS WARRANTY WILL BE VOID. FURTHER, FRYMASTER AND ITS AFFILIATES WILL NOT BE LIABLE FOR ANY CLAIMS, DAMAGES OR EXPENSES INCURRED BY THE CUSTOMER WHICH ARISE DIRECTLY OR INDIRECTLY, IN WHOLE OR IN PART, DUE TO THE INSTALLATION OF ANY MODIFIED PART AND/OR PART RECEIVED FROM AN UNAUTHORIZED SERVICER.

 **NOTICE**

This appliance is intended for professional use only and is to be operated by qualified personnel only. A Frymaster Factory Authorized Servicer (FAS) or other qualified professional should perform installation, maintenance, and repairs. Installation, maintenance, or repairs by unqualified personnel may void the manufacturer's warranty. See Chapter 1 of this manual for definitions of qualified personnel.

 **NOTICE**

This equipment must be installed in accordance with the appropriate national and local codes of the country and/or region in which the appliance is installed. See NATIONAL CODE REQUIREMENTS in Chapter 2 of this manual for specifics.

 **NOTICE**

When installed, this appliance must be electrically grounded in accordance with local codes, or in the absence of local codes, with the National Electrical Code, ANSI/NFPA 70, the Canadian Electrical Code, CSA C22.2, or the appropriate national code of the country in which installed.

 **NOTICE TO U.S. CUSTOMERS**

This equipment is to be installed in compliance with the basic plumbing code of the Building Officials and Code Administrators International, Inc. (BOCA) and the Food Service Sanitation Manual of the U.S. Food and Drug Administration.

 **NOTICE**

This appliance is intended to be used for commercial applications, for example in kitchens of restaurants, canteens, hospitals and in commercial enterprises such as bakeries, butcheries, etc., but not for continuous mass production of food.

 **WARNING**

This equipment is intended for indoor use only. Do not install or operate this equipment in outdoor areas.

 **NOTICE**

The appliance must be installed and used in such a way that any water cannot contact the fat or oil.

 **NOTICE**

Drawings and photos used in this manual are intended to illustrate operational, cleaning and technical procedures and may not conform to onsite management operational procedures.

NOTICE TO OWNERS OF UNITS EQUIPPED WITH CONTROLLERS

U.S.

This device complies with Part 15 of the FCC rules. Operation is subject to the following two conditions: 1) This device may not cause harmful interference, and 2) This device must accept any interference received, including interference that may cause undesired operation. While this device is a verified Class A device, it has been shown to meet the Class B limits.

CANADA

This digital apparatus does not exceed the Class A or B limits for radio noise emissions as set out by the ICES-003 standard of the Canadian Department of Communications.

Cet appareil numérique n'émet pas de bruits radioélectriques dépassant les limites de classe A et B prescrites dans la norme NMB-003 édictée par le Ministre des Communications du Canada.

 **WARNING**

Do not use water jets to clean this equipment.

 **DANGER**

Improper installation, adjustment, maintenance or service, and unauthorized alterations or modifications can cause property damage, injury, or death. Read the installation, operating, and service instructions thoroughly before installing or servicing this equipment.

 **DANGER**

No structural material on the fryer should be altered or removed to accommodate placement of the fryer under a hood. Questions? Call the Frymaster Service Hotline at 1-800-551-8633.

 **DANGER**

Adequate means must be provided to limit the movement of this appliance without depending on or transmitting stress to the electrical conduit. A restraint kit is provided with the fryer. If the restraint kit is missing contact your local KES.

 **NOTICE**

All fryers shipped without factory supplied cords and plug assemblies must be hardwired using flexible conduit to the terminal block located on the rear of the fryer. These fryers should be wired to NEC specifications. Hardwired units must include installation of restraint devices.

 **CAUTION**

No warranty is provided for any Frymaster fryer used in a mobile or marine installation or concession. Warranty protection is only offered for fryers installed in accordance with the procedures described in this manual. Mobile, marine or concession conditions of this fryer should be avoided to ensure optimum performance.

 **DANGER**

The front ledge of the fryer is not a step! Do not stand on the fryer. Serious injury can result from slips or contact with the hot oil.

 **DANGER**

Do not store or use gasoline or other flammable liquids or vapors in the vicinity of this or any other appliance.

 **DANGER**

Do not spray aerosols in the vicinity of this appliance while it is in operation.

 **DANGER**

Keep all items out of drains. Closing actuators may cause damage or injury.

 **DANGER**

The crumb tray in fryers equipped with a filter system must be emptied into a fireproof container at the end of frying operations each day. Some food particles can spontaneously combust if left soaking in certain shortening material.

 **WARNING**

Do not bang fry baskets or other utensils on the fryer's joiner strip. The strip is present to seal the joint between the fry vessels. Banging fry baskets on the strip to dislodge shortening will distort the strip, adversely affecting its fit. It is designed for a tight fit and should only be removed for cleaning.

 **DANGER**

This fryer has a power cord (three-phase) for each frypot. Prior to movement, testing, maintenance and any repair on your Frymaster fryer; disconnect ALL electrical power cords from the electrical power supply.

 **DANGER**

This appliance must be connected to a power supply having the same voltage and phase as specified on the rating plate located on the inside of the appliance door.

 **WARNING**

All wiring connections for this appliance must be made in accordance with the wiring diagram(s) furnished with the appliance. Refer to the wiring diagram(s) supplied with the fryer when installing or servicing this equipment.

⚠ WARNING

Use caution and wear appropriate safety equipment to avoid contact with hot oil or surfaces that may cause severe burns or injury.

⚠ DANGER

This fryer must not be modified to serve as a water-bath unit. This is especially dangerous if adjoining frypots are used for conventional frying. Water splashing or falling into hot oil causes dangerous eruptions in the oil. Personnel near the fryer can be seriously injured.

⚠ DANGER

Do not operate this equipment unless all covers and access panels are in place and properly secured.

⚠ WARNING

If the electrical power supply cord is damaged, it must be replaced by a Frymaster Factory Authorized Servicer or a similarly qualified person in order to avoid a hazard.

⚠ DANGER

Building codes prohibit a fryer with its open tank of hot oil being installed beside an open flame of any type, including those of broilers and ranges.

⚠ DANGER

Hot oil can cause severe burns. Avoid contact. Under all circumstances, oil must be removed from the fryer before attempting to move it to avoid spills, falls, and severe burns. Never attempt to transfer hot oil from one container to another. Fryers may tip and cause personal injury if not secured in a stationary position.

⚠ DANGER

Never operate the appliance with an empty frypot. The frypot must be filled to the fill line with water or cooking oil before energizing the elements. Failure to do so will result in irreparable damage to the elements and may cause a fire.

⚠ NOTICE

If this equipment is wired directly into the electrical power supply, a means for disconnection from the supply having a contact separation of at least 3-mm in all poles must be incorporated in the fixed wiring.

⚠ NOTICE

This equipment must be positioned so that the plug is accessible unless other means for disconnection from the power supply (e.g., a circuit breaker) is provided.

⚠ NOTICE

If this appliance is permanently connected to fixed wiring, it must be connected by means of copper wires having a temperature rating of not less than 167°F (75°C).

⚠ DANGER

NEVER set a complete block of solid shortening on top of heating elements. To do so will damage the elements and increase the potential for flash-point shortening temperatures and subsequent fire.

⚠ WARNING

This appliance is not intended for use by children under the age of 16 or persons with reduced physical, sensory or mental capabilities, or lack of experience and knowledge, unless they have been given supervision concerning use of the appliance by a person responsible for their safety. Do not allow children to play with this appliance.

⚠ WARNING

NEVER drain boil out or cleaning solution into a shortening disposal unit (SDU), a built-in filtration unit, a portable filter unit, or an OQS (Oil Quality Sensor). These units are not intended for this purpose, and will be damaged by the solution and void the warranty.



**1814E with FilterQuick™ Series Electric Fryers
Installation and Operation Manual**

TABLE OF CONTENTS

CHAPTER 1: Introduction

1.1 General 1-1
1.2 Safety Information 1-1
1.3 Controller Information 1-2
1.4 European Community (CE) Specific Information 1-2
1.5 Installation, Operating, and Service Personnel 1-2
1.6 Definitions 1-2
1.7 Shipping Damage Claim Procedure 1-3
1.8 Reading Model Numbers 1-4
1.9 Service Information 1-4

CHAPTER 2: Installation Instructions

2.1 General Installation Requirements 2-1
 2.1.1 Clearance and Ventilation 2-2
 2.1.2 Electrical Grounding Requirements 2-2
 2.1.3 Australian Requirements 2-3
2.2 Power Requirements 2-3
2.3 Positioning the Fryer 2-4
2.4 Installing the JIB Cradle 2-4
2.5 Installing the Oil Saddle Reservoir 2-5

CHAPTER 3: Operating Instructions

3.1 Equipment Setup and Start-Up Procedures 3-2
3.2 Operation 3-3
3.3 Oil Attendant® Automatic Topoff 3-3
 3.3.1 Adding Oil to the Fryer 3-3
 3.3.1.1 Install the JIB (Jug in Box) Oil Reservoir 3-3
 3.3.1.2 Adding Oil to the Oil Saddle Reservoir 3-4
 3.3.2 Routine Oil Changes 3-4
 3.3.2.1 Routine Oil Changes JIB (Jug in Box) 3-4
 3.3.2.2 Routine Oil Changes (Saddle Oil Reservoir) 3-5

CHAPTER 4: Filtration Instructions

4.1 Introduction 4-1
4.2 Preparation for Use with Filter Paper or Filter Pad 4-1
4.3 FilterQuick™ with Fingertip Filtration 4-2
4.4 Troubleshooting FilterQuick™ with Fingertip Filtration 4-3
 4.4.1 Incomplete Filtration 4-3
4.5 Filter Busy 4-4
4.6 Draining and Refilling Vats, and Disposing of Waste Oil 4-5

CHAPTER 5: Preventive Maintenance

5.1 Cleaning the Fryer 5-1
5.2 Daily Checks and Service 5-1
 5.2.1 Inspect Fryer for Damage 5-1

5.2.2	Clean Fryer Cabinet Inside and Out	5-1
5.2.3	Clean the FilterQuick™ Filtration System.....	5-1
5.2.4	Clean Detachable Parts and Accessories	5-2
5.3	Weekly Checks and Service	5-2
5.3.1	Drain, Clean Frypot and Heating Elements	5-2
5.3.2	Boiling Out the Frypot.....	5-2
5.3.3	Cleaning the Oil Saddle Reservoir.....	5-3
5.4	Monthly Checks and Service	5-4
5.4.1	Check FilterQuick™ Controller Setpoint Accuracy	5-4
5.5	Quarterly Checks and Service.....	5-4
5.5.1	Replace O-rings	5-4
5.6	Annual/Periodic System Inspection.....	5-4
5.6.1	Fryer.....	5-4
5.6.2	1814E with FilterQuick™ Filtration System	5-5

CHAPTER 6: Operator Troubleshooting

6.1	Introduction.....	6-1
6.2	Troubleshooting.....	6-2
6.2.1	Controller and Heating Problems	6-2
6.2.2	Error Message and Display Problems.....	6-2
6.2.3	Filtration Problems	6-4
6.2.4	Basket Lift Problems	6-5
6.2.5	Auto Top Off Problems	6-5
6.2.6	Error Log Codes.....	6-6
6.2.7	High Limit Test.....	6-7
6.2.8	OQS (Oil Quality Sensor).....	6-8

APPENDIX A: Bulk Oil Instructions

1814E with FILTERQUICK™ SERIES ELECTRIC FRYER

CHAPTER 1: INTRODUCTION

NOTE: The Frymaster 1814E with FilterQuick™ fryer requires a start-up, demonstration and training before normal restaurant operations can begin.

1.1 General

Read the instructions in this manual thoroughly before attempting to operate this equipment. This manual covers all configurations of 1814E with FilterQuick™ electric models. The fryers in this model family have most parts in common, and when discussed as a group, will be referred to as 1814E with FilterQuick™ fryers.

The 1814E with FilterQuick™ fryers feature an open frypot with rotating elements, automatic oil top off and semi-automatic fingertip filtration unit. The Euro-Look design incorporates a rounded topcap and a large round drain, which ensures that fries and other debris, will be washed into the filter pan. The 1814E with FilterQuick™ fryers are controlled with a FilterQuick™ controller. Fryers in this series come in full arrangements, and can be purchased as single units or in batteries of up to four fryers.

1.2 Safety Information

Before attempting to operate your unit, read the instructions in this manual thoroughly.

Throughout this manual, you will find notations enclosed in double-bordered boxes similar to the one below.

 **DANGER**

Hot oil causes severe burns. Never attempt to move a fryer containing hot oil or to transfer hot oil from one container to another.

 **CAUTION** boxes contain information about actions or conditions that *may cause or result in a malfunction of your system.*

 **WARNING** boxes contain information about actions or conditions that *may cause or result in damage to your system,* and which may cause your system to malfunction.

 **DANGER** boxes contain information about actions or conditions that *may cause or result in injury to personnel,* and which may cause damage to your system and/or cause your system to malfunction.

The 1814E with FilterQuick™ fryers incorporate a high-temperature detection feature which shuts off power to the elements should the temperature controls fail.

1.3 Controller Information

This equipment has been tested and found to comply with the limits for a Class A digital device, pursuant to Part 15 of the FCC rules. While this device is a verified Class A device, it has been shown to meet the Class B limits. These limits are designed to provide reasonable protection against harmful interference when the equipment is operated in a commercial environment. This equipment generates, uses and can radiate radio frequency energy and, if not installed and used in accordance with the instruction manual, may cause harmful interference to radio communications. Operation of the equipment in a residential area is likely to cause harmful interference in which case the user will be required to correct the interference at their own expense.

The user is cautioned that any changes or modifications not expressly approved by the party responsible for compliance could void the user's authority to operate the equipment.

If necessary, the user should consult the dealer or an experienced radio and television technician for additional suggestions.

The user may find the following booklet prepared by the Federal Communications Commission helpful: "How to Identify and Resolve Radio-TV Interference Problems". This booklet is available from the U.S. Government Printing Office, Washington, DC 20402, Stock No. 004-000-00345-4.

1.4 European Community (CE) Specific Information

The European Community (CE) has established certain specific standards regarding equipment of this type. Whenever a difference exists between CE and non-CE standards, the information or instructions concerned are identified by means of shadowed boxes similar to the one below.

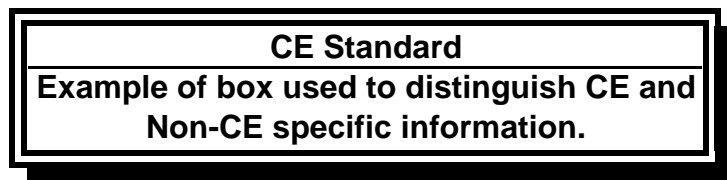

1.5 Installation, Operating, and Service Personnel

Operating information for Frymaster equipment has been prepared for use by qualified and/or authorized personnel only, as defined in Section 1.6. **All installation and service on Frymaster equipment must be performed by qualified, certified, licensed, and/or authorized installation or service personnel, as defined in Section 1.6.**

1.6 Definitions

QUALIFIED AND/OR AUTHORIZED OPERATING PERSONNEL

Qualified/authorized operating personnel are those who have carefully read the information in this manual and have familiarized themselves with the equipment functions, or who have had previous experience with the operation of the equipment covered in this manual.

QUALIFIED INSTALLATION PERSONNEL

Qualified installation personnel are individuals, firms, corporations, and/or companies which, either in person or through a representative, are engaged in and are responsible for the installation of electrical appliances. Qualified personnel must be experienced in such work, be familiar with all electrical precautions involved, and have complied with all requirements of applicable national and local codes.

QUALIFIED SERVICE PERSONNEL

Qualified service personnel are those who are familiar with Frymaster equipment and who have been authorized by Frymaster, L.L.C. to perform service on the equipment. All authorized service personnel are required to be equipped with a complete set of service and parts manuals, and to stock a minimum amount of parts for Frymaster equipment. A list of Frymaster Factory Authorized Servicers (FAS's) is located on the Frymaster website at www.frymaster.com. *Failure to use qualified service personnel will void the Frymaster warranty on your equipment*

1.7 Shipping Damage Claim Procedure

What to do if your equipment arrives damaged:

Please note that this equipment was carefully inspected and packed by skilled personnel before leaving the factory. The freight company assumes full responsibility for safe delivery upon acceptance of the equipment.

1. **File Claim for Damages Immediately** - regardless of extent of damage.
2. **Inspect For and Record All Visible Loss or Damage**, and ensure that this information is noted on the freight bill or express receipt and is signed by the person making the delivery.
3. **Concealed Loss or Damage**- If damage is unnoticed until equipment is unpacked, notify the freight company or carrier **immediately** upon discovery and file a concealed damage claim. This must be submitted within 15 days of date of delivery. Be sure to retain container for inspection.

<p><i>Frymaster</i> DOES NOT ASSUME RESPONSIBILITY FOR DAMAGE OR LOSS INCURRED IN TRANSIT.</p>

1.8 Reading Model Numbers

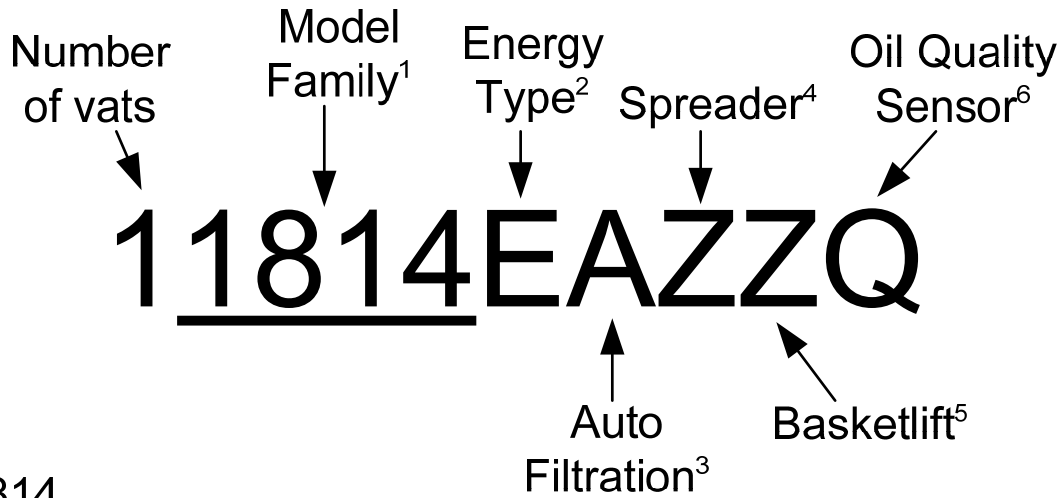

1 = 1814

2 = E-Electric, N-Natural Gas, P-Propane Gas

3 = A-Auto Filtration

4 = S-Spreader; Z-none

5 = B-Basket Lift; Z-none

6 = Q-Oil Quality Sensor; Z-none

1.9 Service Information

For non-routine maintenance or repairs, or for service information, contact your local Frymaster Authorized Servicer (FAS). In order to assist you quickly, the Frymaster Authorized Servicer (FAS) or Service Department representative requires certain information about your equipment. Most of this information is printed on a data plate affixed to the inside of the fryer door. Part numbers are found in the Service and Parts Manual. Parts orders may be placed directly with your local FAS or distributor. A list of Frymaster Factory Authorized Servicers (FAS's) is located on the Frymaster website at www.frymaster.com. If you do not have access to this list, contact the Frymaster Service Department at 1-800-551-8633 or 1-318-865-1711 or by email at service@frymaster.com.

The following information will be needed in order to assist you efficiently:

Model Number _____

Serial Number _____

Voltage _____

Nature of the Problem _____

RETAIN AND STORE THIS MANUAL IN A SAFE PLACE FOR FUTURE USE.

1814E with FILTERQUICK™ SERIES ELECTRIC FRYER

CHAPTER 2: INSTALLATION INSTRUCTIONS

2.1 General Installation Requirements

Proper installation is essential for the safe, efficient, trouble-free operation of this appliance.

Qualified, licensed, and/or authorized installation or service personnel, as defined in Section 1.6 of this manual, should perform all installation and service on Frymaster equipment.

Failure to use qualified, licensed, and/or authorized installation or service personnel (as defined in Section 1.6 of this manual) to install or otherwise service this equipment will void the Frymaster warranty and may result in damage to the equipment or injury to personnel.

Where conflicts exist between instructions and information in this manual and local or national codes or regulations, installation and operation shall comply with the codes or regulations in force in the country in which the equipment is installed.

Service may be obtained by contacting your local Frymaster Authorized Servicer.

NOTICE

All fryers shipped without factory supplied cords and plug assemblies must be hardwired using flexible conduit to the terminal block located on the rear of the fryer. These fryers should be wired to NEC specifications. Hardwired units must include installation of restraint devices.

DANGER

Adequate means must be provided to limit the movement of this appliance without depending on or transmitting stress to the electrical conduit. A restraint kit is provided with the fryer. If the restraint kit is missing contact your local Frymaster Authorized Servicer (FAS).

NOTICE

If this equipment is wired directly into the electrical power supply, a means for disconnection from the supply having a contact separation of at least 3-mm in all poles must be incorporated in the fixed wiring.

NOTICE

This equipment must be positioned so that the plug is accessible unless other means for disconnection from the power supply (e.g., a circuit breaker) is provided.

NOTICE

If this appliance is permanently connected to fixed wiring, it must be connected by means of copper wires having a temperature rating of not less than 167°F (75°C).

NOTICE

If the electrical power supply cord is damaged, it must be replaced by a Frymaster Authorized Servicer or a similarly qualified person in order to avoid a hazard.

DANGER

This appliance must be connected to a power supply having the same voltage and phase as specified on the rating plate located on the inside of the appliance door.

DANGER

All wiring connections for this appliance must be made in accordance with the wiring diagram(s) furnished with the appliance. Refer to the wiring diagram(s) affixed to the inside of the appliance door when installing or servicing this equipment.

DANGER

Do not attach an apron drainboard to a single fryer. The fryer may become unstable, tip over, and cause injury. The appliance area must be kept free and clear of combustible material at all times.

DANGER

Building codes prohibit a fryer with its open tank of hot oil being installed beside an open flame of any type, including those of broilers and ranges.

In the event of a power failure, the fryer(s) will automatically shut down. If this occurs, turn the power switch OFF. Do not attempt to start the fryer(s) until power is restored.

2.1.1 Clearance and Ventilation

This appliance must be kept free and clear of combustible material, except that it may be installed on combustible floors.

A clearance of 6 inches (15cm) must be provided at both sides and back adjacent to combustible construction. A minimum of 24 inches (61cm) should be provided at the front of the equipment for servicing and proper operation.

WARNING

Do not block the area around the base or under the fryers.

2.1.2 Electrical Grounding Requirements

All electrically operated appliances must be grounded in accordance with all applicable national and local codes, and, where applicable, CE codes. All units (cord connected or permanently connected) should be connected to a grounded power supply system. A wiring diagram is located on the inside of the fryer door. Refer to the rating plate on the inside of the fryer door for proper voltages.

The equipotential grounding lug allows all the equipment in the same location to be electrically connected to ensure there is no electrical potential difference between the units, which could be hazardous.



2.1.3 Australian Requirements

To be installed in accordance with AS 5601 and AS/NZS 3000:2007 local authorities, gas, electricity, and any other relevant statutory regulations.

If casters are fitted, the installation must comply with AS5601 and AS1869 requirements.

2.2 Power Requirements

The optional three phase supply plug for 208v and 240v delta configuration fryers are rated at 60 amps, 250 VAC and is NEMA configuration 15-60P.

Three (3) Phase Requirements					
MODEL	VOLTAGE	WIRE SERVICE	MINIMUM WIRE SIZE		AMPS (per leg)
			AWG	(mm)	
1814E 14kW	208	3	6	(4.11)	39
1814E 14kW	240	3	6	(4.11)	34
1814E 14kW	480	3	8	(2.59)	17
1814E 14kW	220/380	4	6	(4.11)	21
1814E 14kW	240/415	4	6	(4.11)	20
1814E 14kW	230/400	4	6	(4.11)	21
1814E 17kW	208	3	6	(4.11)	48
1814E 17kW	240	3	6	(4.11)	41
1814E 17kW	480	3	6	(4.11)	21
1814E 17kW	220/380	4	6	(4.11)	26
1814E 17kW	240/415	4	6	(4.11)	24
1814E 17kW	230/400	4	6	(4.11)	25
1814E 22kW	208	3	4	(5.19)	61
1814E 22kW	240	3	4	(5.19)	53
1814E 22kW	480	3	6	(4.11)	27
1814E 22kW	220/380	4	6	(4.11)	34
1814E 22kW	240/415	4	6	(4.11)	31
1814E 22kW	230/400	4	6	(4.11)	32

Single Phase Requirements					
MODEL	VOLTAGE	WIRE SERVICE	MINIMUM WIRE SIZE		AMPS (per leg)
			AWG	(mm)	
1814E 14kW	208	2	3	(5.83)	68
1814E 14kW	240	2	4	(5.19)	59
1814E 14kW	480	2	8	(3.26)	30

NOTICE

If this appliance is permanently connected to fixed wiring, it must be connected by means of copper wires having a temperature rating of not less than 167°F (75°C).

DANGER

This appliance must be connected to a power supply having the same voltage and phase as specified on the rating plate located on the inside of the appliance door.

DANGER

All wiring connections for this appliance must be made in accordance with the wiring diagram(s) furnished with the appliance. Refer to the wiring diagram(s) affixed to the inside of the appliance door when installing or servicing this equipment.

2.3 Positioning the Fryer

⚠ DANGER

No structural material on the fryer should be altered or removed to accommodate placement of the fryer under a hood. Questions? Call the Frymaster Dean Service Hotline at 1-800-551-8633.

1. Once the fryer has been positioned at the frying station, use a carpenter's level placed across the top of the frypot to verify that the unit is level, both side-to-side and front-to-back.

To level fryers, adjust the casters being careful to ensure the fryer(s) are at the proper height in the frying station.

When the fryer is leveled in its final position, install the restraints provided by the KES to limit its movement so that it does not depend on or transmit stress to the electrical conduit or connection. Install the restraints in accordance with the provided instructions. If the restraints are disconnected for service or other reasons, they must be reconnected before the fryer is used.

⚠ DANGER

Adequate means must be provided to limit the movement of this appliance without depending on or transmitting stress to the electrical conduit. A restraint kit is provided with the fryer. If the restraint kit is missing contact your local KES.

⚠ DANGER

Hot oil can cause severe burns. Avoid contact. Under all circumstances, oil must be removed from the fryer before attempting to move it to avoid oil spills, falls and severe burns. This fryer may tip and cause personal injury if not secured in a stationary position.

2. Close fryer drain-valve(s).
3. Clean and fill frypot(s) to the bottom oil level line with cooking oil. (See *Equipment Setup and Shutdown Procedures* in Chapter 3.)

2.4 Installing the JIB Cradle (Applicable to fryer batteries of 2 or more only)

Open the fryer door (typically the far right door) and remove the cross brace used for shipping support by removing the four screws (see Figure 1). Install the JIB cradle shipped in the accessories pack with the screws that were removed in the cross brace removal step (see Figure 2). If using the solid shortening option see Appendix A in the rear of this manual for installation instructions. Install the optional JIB splash shield to protect the bottom of the JIB (see Figure 3).

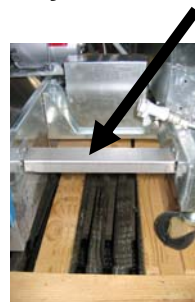

Figure 1

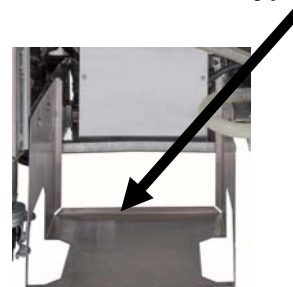

Figure 2



Figure 3

2.5 Installing the Oil Saddle Reservoir (Applicable to fryers with side oil saddle reservoir only)

Carefully cut the shipping strap around the oil saddle hose on the rear of the fryer. Attach the hose to the oil saddle reservoir quick disconnect on the bottom of the reservoir. Lift up the orange quick disconnect and insert the male adaptor of the hose. Once the male end is fully inserted, release the quick disconnect to attach. Once attached, pull gently on the hose to ensure it is connected (see Figure 4).

Using the enclosed strap, attach to the saddle hose as shown. Attach to the oil saddle handle to keep the hose off of the floor (see Figure 5).



Figure 4

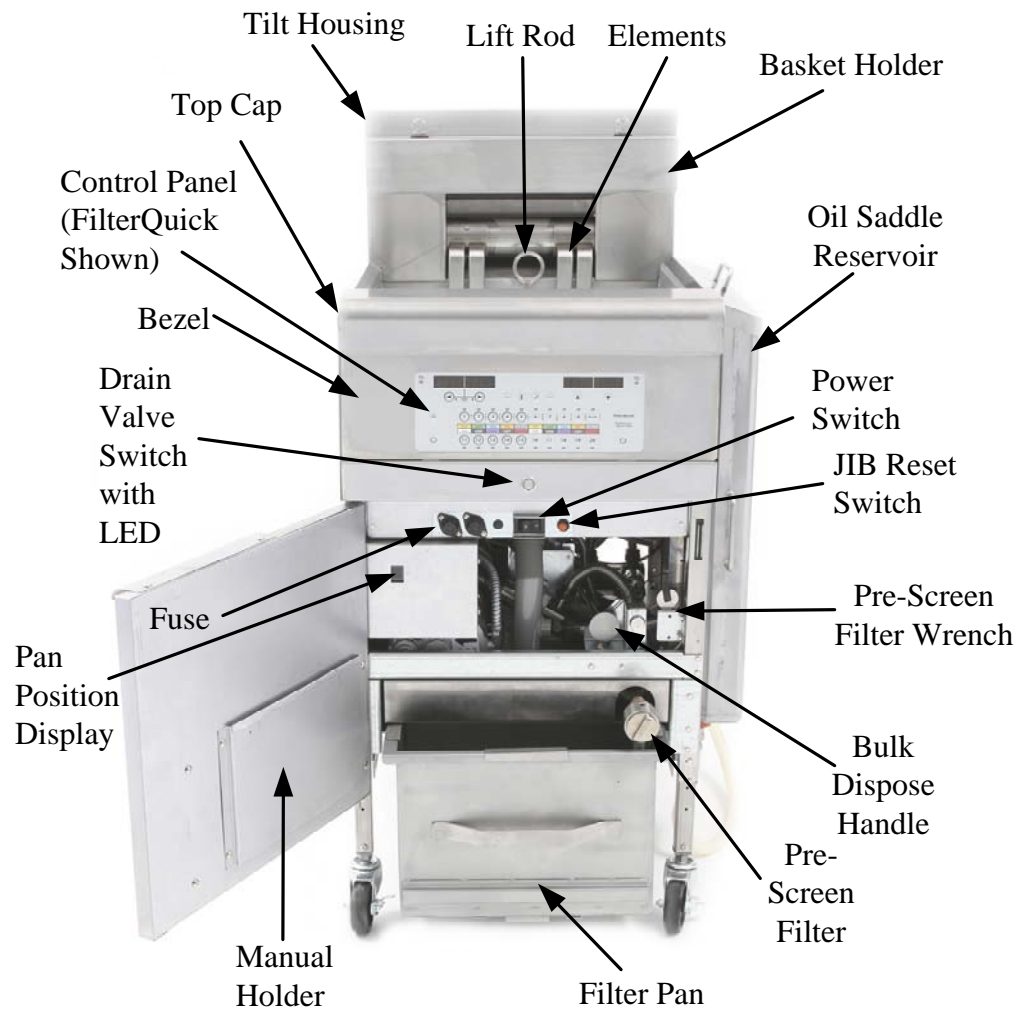

Figure 5

1814E with FILTERQUICK™ SERIES ELECTRIC FRYER

CHAPTER 3: OPERATING INSTRUCTIONS

FINDING YOUR WAY AROUND THE 1814E with FILTERQUICK™ SERIES ELECTRIC FRYER



TYPICAL CONFIGURATION (1814E with FILTERQUICK™ ELECTRIC SHOWN)

NOTE: The appearance of your fryer may differ slightly from that shown depending upon configuration and date of manufacture.

3.1 Equipment Setup and Shutdown Procedures

Setup

 **DANGER**

Never operate the appliance with an empty frypot. The frypot must be filled to the fill line with water or oil before energizing the elements. Failure to do so will result in irreparable damage to the elements and may cause a fire.

 **DANGER**

Remove all drops of water from the frypot before filling with oil. Failure to do so will cause spattering of hot liquid when the oil is heated to cooking temperature.

 **WARNING**

The FilterQuick™ is not intended to use solid shortening without a solid shortening kit installed. Use only liquid shortening with this fryer if a solid shortening kit is not installed. The use of solid shortening without a solid shortening kit will clog the oil lines. The oil capacity of the 1814E with FilterQuick™ fryer is 60 lbs. (7.93 gallons/30 liters) at 70°F (21°C).

1. Fill the frypot with cooking oil to the bottom OIL LEVEL line located on the rear of the frypot. This will allow for oil expansion as heat is applied. Do not fill cold oil any higher than the bottom line; overflow may occur as heat expands the oil. For bulk oil systems see Section 1.9.8 in the *FilterQuick™ Controller Manual 8197206* for instructions to fill the vat from bulk.
2. Ensure that the power cord(s) is/are plugged and locked (if applicable) into the appropriate receptacle(s). Verify that the face of the plug is flush with the outlet plate, with no portion of the prongs visible.
3. Ensure that the power is switched on with the master switch, located behind the fryer door cabinet on the front panel of the component box, next to the fuse.
4. Ensure that the controller is switched ON by pressing the ON/OFF switch  to the ON position. When the controller is switched on, the fryer will begin heating and will display **MELT-CYCLE** alternating with the fryer temperature until the fryer reaches 180°F (82°C). The fryer temperature is displayed until within 10°F of setpoint, the controller displays -----. Once the fryer reaches setpoint, the controller display changes **READY** and the fryer is ready for use. To exit the melt cycle, press the EXIT COOL button. Answer YES to EXIT MELT? If solid shortening is used, the MELT cycle **MUST** be used to melt the shortening. **DO NOT DISABLE OR CANCEL THE MELT CYCLE IF USING SOLID SHORTENING.**
5. Ensure that the oil level is at the top OIL LEVEL line when the oil is at its cooking temperature. Auto top off will ensure the oil level is maintained at the top OIL LEVEL line.
6. The maximum batch load for French Fries in oil or fat shall be no more than 1½ pounds or 0.7 kilograms.

Shutdown

1. Filter the oil and clean the fryers (See Chapters 5 and 6).
2. Turn the fryer off.
3. Place the frypot covers on the frypots.

3.2 Operation

This fryer is equipped with FilterQuick™ controller(s) (illustrated below). Refer to the *FilterQuick™ Controller Operation Manual 8197206* for programming and operating procedures.



FILTERQUICK CONTROLLER

Refer to Chapter 5 of this manual for operating instructions for the built-in filtration system.

3.3 Oil Attendant® Automatic Top-Off

When the Oil Attendant® top-off oil system is in place on the fryer, oil is continually topped off in the frypots from a reservoir in or the saddle oil reservoir attached to the cabinet. The reservoir holds a 35 pound box of oil. In a typical operation this will last approximately two days before changing.

Components of the system are annotated at the right and below (see Figures 1 and 2).

NOTE: The top off system is intended to top off the frypots, not fill them. The frypots will require manual filling upon startup and after disposal.

JIB (Jug In Box) Low Reset Switch: Resets the ATO system after oil change.

Special Cap: Has plumbing attached to draw oil from the reservoir to the fryer vats.

Jug In Box (JIB): The JIB is the reservoir for the oil.

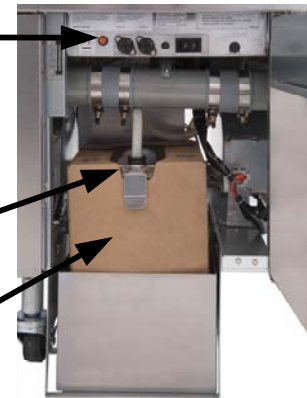

Figure 1

3.3.1 Adding Oil to the Fryer

3.3.1.1 Install the JIB (Jug In Box) Oil Reservoir (JIB units only)

Remove the original lid from the oil container and foil liner. Replace with the provided cap, which has connected suction hardware. Ensure the feeder tube from the cap reaches to the bottom of the oil container.

Place the oil container inside the cabinet and slide it into place (as shown on the following page).

ATO Reset Switch: Resets the ATO system after oil change.

Saddle Reservoir: Has plumbing attached to draw oil from the reservoir to the fryer vats.



Figure 2

Avoid catching the suction hardware on the cabinet interior as the container is placed in the fryer. Press and hold the orange reset button for 5 seconds (see Figure 7 on the following page).

3.3.1.2 Adding Oil to the Oil Saddle Reservoir (Saddle Oil Reservoir only)

Remove the Oil Saddle Reservoir lid (see Figure 3) and fill with oil. Once the reservoir is full ensure the lid is placed over the reservoir. Ensure the quick disconnect fitting with hose is fully seated to the fitting on the bottom of the oil saddle.



Figure 3

The system is now ready for operation. As the fryer heats to preprogrammed temperatures, the system will energize and then slowly add oil to the frypot as needed, until the oil reaches an optimal level.

3.3.2 Routine Oil Changes

When the oil reservoir level is low, the controller displays **TOPOFF OIL EMPTY** in the left display and **YES NO** in the right display. Press **▲ (YES)** and follow the prompts. Once the JIB is replaced or the saddle filled press and hold the JIB button for 5 (five) seconds to reset top off system. Some procedures may differ from photos shown. Follow manufacturer's instructions for changing the JIB. If using a saddle oil reservoir see section 3.3.2.2.

3.3.2.1 Routine Oil Changes (JIB only)

1. Open the cabinet and slide the JIB from the cabinet (see Figure 4).
2. Remove the cap and pour any remaining oil in the container into all fry vats equally (see Figure 5).



Figure 4



Figure 5

3. With the jug upright remove the cap and foil seal (see Figure 6).
4. Put the tube in the new full container (see Figure 7).



Figure 6



Figure 7

5. Slide the JIB onto the shelf inside the fryer cabinet (as seen in Figure 4).
6. Press and hold the orange JIB reset switch **five (5) seconds** to reset the top off system (see Figure 8).

WARNING:
Do not add **HOT** or **USED** oil to a JIB or Saddle Oil Reservoir.



Figure 8

3.3.2.2 Routine Oil Changes (Saddle Oil Reservoir only)

1. Remove saddle oil reservoir lid.
2. Fill the oil saddle with oil.
3. Replace saddle oil reservoir lid.
4. Press and hold the orange ATO reset switch five (5) seconds to reset the top off system (see Figure 8 on the previous page).

The system is now ready for operation. As the fryer heats to preprogrammed temperatures, the system will energize and then slowly add oil to the frypot as needed, until the oil reaches an optimal level.

3.3.3 Bulk Oil Systems

Instructions for installing and using bulk oil systems are found in Appendix A located at the rear of this manual.

1814E with FILTERQUICK™ SERIES ELECTRIC FRYERS

CHAPTER 4: FILTRATION INSTRUCTIONS

4.1 Introduction

The 1814E with FilterQuick™ with fingertip filtration system allows the oil in one frypot to be safely and efficiently filtered while the other frypots in a battery remain in operation.

Section 4.2 covers preparation of the filter system for use. Operation of the system is covered in Section 4.3.

⚠ WARNING

The on-site supervisor is responsible for ensuring that operators are made aware of the inherent hazards of operating a hot oil filtering system, particularly the aspects of oil filtration, draining and cleaning procedures.

⚠ WARNING

The filter pad or paper **MUST** be replaced daily or when the sediment level exceeds the height of the hold down ring.

4.2 Preparing the 1814E with FilterQuick™ with Fingertip Filtration System for Use with Filter Paper or Filter Pad

The 1814E with FilterQuick™ with fingertip filtration system allows the oil in one frypot to be safely and efficiently filtered while the other frypots in a battery remain in operation. The 1814E with FilterQuick™ filtration system uses a filter paper configuration which includes a crumb tray, large hold-down ring, and metal filter screen.

1. Pull the filter pan out from the cabinet and remove the crumb tray, hold-down ring, filter paper and filter screen (see Figure 1). Clean all components with a solution of detergent and hot water then dry thoroughly.

Disposal instructions are in the controller manual 8197206.

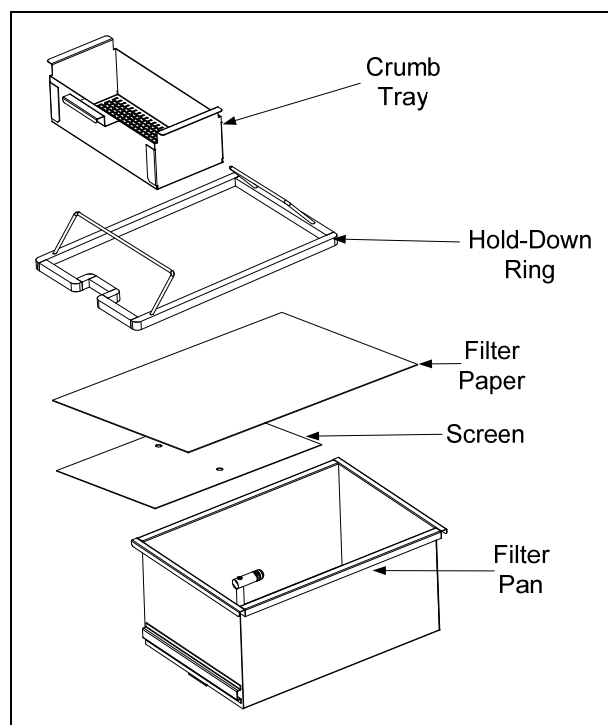

Figure 1

2. Inspect the filter pan connection fitting to ensure that both O-rings are in good condition (see Figure 2).
3. Then in reverse order, place the metal filter screen in the center of the bottom of the pan, then lay a sheet of filter paper on top of the screen, overlapping on all sides (see Figure1). If using a filter pad, ensure the rough side of the pad is up and lay the pad over the screen, making sure that the pad is in between the embossed ridges of the filter pan.
4. Position the hold-down ring over the filter paper and lower the ring into the pan, allowing the paper to rest on the sides of the filter pan (see Figure 3).
5. When the hold-down ring is in position, if using filter paper, sprinkle one packet of filter powder evenly over the paper. (See Figure 4)
6. Replace the crumb tray in the filter pan, then push the filter pan back into the fryer, positioning it under the drain.

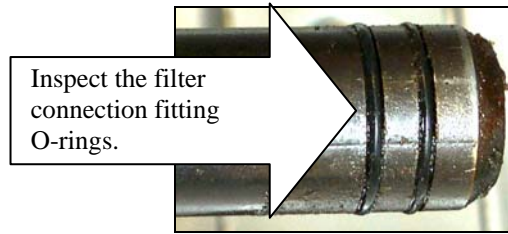

Figure 2



Figure 3

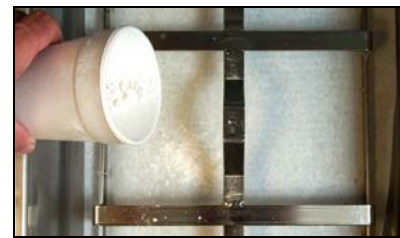

Figure 4

DO NOT USE FILTER POWDER WITH THE PAD!

7. Push the filter pan back into the fryer, positioning it under the fryer. Ensure “**F**” is displayed on the MIB board. The filtration system is now ready for use.

⚠ DANGER

Do not drain more than one frypot at a time into the built-in filtration unit to avoid overflow and spillage of hot oil that may cause severe burns, slipping and falling.

⚠ DANGER

The crumb tray in fryers equipped with a filter system must be emptied into a fireproof container at the end of frying operations each day. Some food particles can spontaneously combust if left soaking in certain shortening material.

⚠ WARNING

Do not bang fry baskets or other utensils on the fryer’s joiner strip. The strip is present to seal the joint between the fry vessels. Banging fry baskets on the strip to dislodge shortening will distort the strip, adversely affecting its fit. It is designed for a tight fit and should only be removed for cleaning.

4.3 1814E with FilterQuick™ with Fingertip Filtration

The FilterQuick™ controller has a feature that will prompt the operator to begin the semi-automatic filtration process, after a number of preset cook cycles.

A FilterQuick™ controller controls the semi-automatic filtration system on the 1814E with FilterQuick™ fryer. After a preset number of cook cycles the controller displays **FILTER NOW?** alternating with **YES NO**. If **NO** is selected or a cook cycle is started, the controller will resume normal operation for a set amount of cooks and then prompt for a filter again. The **FILTER NOW?** prompt is displayed once the cooks till filter or filter prompt count is satisfied. Refer to the FilterQuick™ controller manual for filter steps. All messages need to be confirmed or cleared on all controllers prior to starting any filtration process.

4.4 Troubleshooting the 1814E with FilterQuick™ with Fingertip Filtration

4.4.1 Incomplete Filtration

Should the filter procedure fail after the filter paper or pad was changed an error message is generated.

The controller displays **IS VAT FULL?** alternating with **YES NO**.
The MIB board displays three horizontal lines.

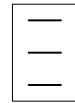

1. If the vat is full press the **▲ (YES)** button to continue. The controller returns to idle cook mode or OFF.

If the pot is not filled completely continue to next step.

2. Press **▼ (NO)** if pot is not filled completely.

The controller displays **FILLING** while the pump runs again. When the pump stops, the controller displays **IS VAT FULL?** alternating with **YES NO** again. If the vat is full go to step 1. If the vat is not completely filled continue.

3. Press **▼ (NO)** if pot is not filled completely.

The controller displays **FILLING** while the pump runs again. When the pump stops, the controller displays **IS VAT FULL?** alternating with **YES NO** again. If the vat is full go to step 1. If the vat is not completely filled continue.

4. Press **▼ (NO)** if pot is not filled completely. If this is the sixth consecutive sequence of incomplete filtration skip to step 8.

The controller displays **CHANGE FILTER PAPER?** alternating with **YES NO** and an alarm.

5. Press **▲ (YES)** to continue.

Pressing **▼ (NO)** allows the fryer to return to cook mode in most cases for four minutes or 15 minutes if the paper is expired*, ending with the **CHANGE FILTER PAPER?** alternating with **YES NO** display.

This repeats until **YES** is chosen.

The controller displays **REMOVE PAN**.

***NOTE:** If the filter paper change time has expired, normally every 25 hours, the **CHANGE FILTER PAPER** message repeats every 15 minutes instead of every four minutes.

6. Remove the pan. The controller display changes to **CHANGE PAPER**. Change the filter paper and ensure the filter pan has been pulled forward, out of the cabinet for at least 30 seconds. Once the pan has been out for 30 seconds the controller displays **OFF**. Ensure the pan is completely dry with no water or moisture and assembled correctly. Push the filter pan back into the fryer. Ensure “**P**” is displayed on the MIB board.
7. Switch the controller on. The controller displays the fryer temperature until the fryer reaches setpoint.
8. If a filtration error occurs six consecutive times, the return valve closes and the controller displays **SERVICE REQUIRED** alternating with **YES** and an alarm.
9. Press **▲ (YES)** to silence alarm and continue.

The controller displays **SYSTEM ERROR** and the error message for 15 seconds changing to **SYSTEM ERROR FIXED** alternating with **YES NO**.

10. Press **▼ (NO)** to continue cooking. Call your FAS to repair and reset the fryer. The error will be re-displayed every 15 minutes until the issue is repaired. Semi-automatic filtration and auto top off is disabled until the fryer is reset.

4.5 Filter Busy

When **FILTER BUSY** is displayed on the controller, the system is waiting on another vat to be filtered or waiting on another issue to clear. Wait 15 minutes to see if problem is corrected. If not, call your local FAS.

DANGER

Do not drain more than one frypot at a time into the built-in filtration unit to avoid overflow and spillage of hot oil that may cause severe burns, slipping and falling.

WARNING

The filter pump is equipped with a manual reset switch in case the filter motor overheats or an electrical fault occurs. If this switch trips, turn off power to the filter system and allow the pump motor to cool 20 minutes before attempting to reset the switch (see photo on the next page).

WARNING

Use caution and wear appropriate safety equipment when resetting the filter pump reset switch. Resetting the switch must be accomplished with care to avoid the possibility of a serious burn from careless maneuvering around the drain tube and frypot.

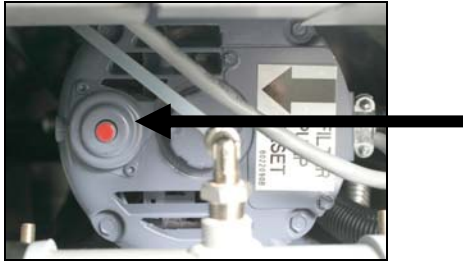

Filter Pump Reset Switch

4.6 Draining and Refilling Vats, and Disposing of Oil

When cooking oil requires changing, drain the oil into an appropriate container for transport to the disposal container. (For safe, convenient draining and disposal of used oil, Frymaster recommends the use of the Frymaster Shortening Disposal Unit (SDU) for JIB and Oil Saddle Reservoir systems. The SDU is available through your local distributor.) **Do not drain boil-out solution into an SDU.** **NOTE:** Only an SDU built after January 2004 will fit beneath the drain. If a shortening disposal unit is not available, allow the oil to cool to 100°F (38°C), then drain the oil into a METAL container with a capacity of EIGHT (8) gallons (30 liters) or larger to prevent oil from spilling. If using a bulk oil system, follow the disposal and refilling instructions for bulk oil in the FilterQuick Controller Manual 8197206.

⚠ DANGER

When draining oil into an appropriate METAL container, make sure the container will hold at least EIGHT gallons (30 liters) or more, otherwise hot liquid could overflow and cause injury.

⚠ DANGER

Allow oil to cool to 100°F (38°C) before draining into an appropriate METAL container for disposal.

⚠ DANGER

When draining oil into a disposal unit, do not fill above the maximum fill line located on the container.

⚠ DANGER

Draining and filtering of cooking oil must be accomplished with care to avoid the possibility of a serious burn caused by careless handling. The oil to be filtered is at or near 350°F (177°C). Wear all appropriate safety equipment when draining and filtering oil.

⚠ WARNING

NEVER drain boil-out solution into an SDU. Boil-out solution can cause damage to an SDU.

1. Turn the controller power switch to the **OFF** position.

2. Remove the filter pan and position the SDU or METAL container with a sealable cover with a capacity of EIGHT gallons (30 liters) or larger under the fryer drainpipe to drain the oil. The METAL container must be able to withstand the heat of the oil and hold hot liquids.
3. Follow the instructions for disposing of oil in the FilterQuick™ controller manual for disposal or draining steps. If the drain valve becomes clogged with food particles, use the Fryer's Friend (poker-like tool) that was provided with the fryer, to clear the blockage.

 **DANGER**

DO NOT hammer on the drain valve with the cleanout rod or other objects. Damage to the ball inside will result in leaks and will void the Frymaster warranty.

4. After draining the oil, clean all food particles and residual oil from the frypot. BE CAREFUL, this material may still cause severe burns if it comes in contact with bare skin.
5. Once the drain valve is closed, fill the frypot with clean, filtered or fresh cooking oil to the bottom OIL-LEVEL line.

1814E with FILTERQUICK™ SERIES ELECTRIC FRYER

CHAPTER 5: PREVENTATIVE MAINTENANCE

5.1 Cleaning the Fryer

 **DANGER**

The crumb tray in fryers equipped with a filter system must be emptied into a fireproof container at the end of frying operations each day. Some food particles can spontaneously combust if left soaking in certain shortening material.

 **DANGER**

Never attempt to clean the fryer during the frying process or when the frypot is filled with hot oil. If water comes in contact with oil heated to frying temperature, it will cause spattering of the oil, which can result in severe burns to nearby personnel.

 **WARNING**

Use a commercial-grade cleaner formulated to effectively clean and sanitize food-contact surfaces. Read the directions for use and precautionary statements before use. Particular attention must be paid to the concentration of cleaner and the length of time the cleaner remains on the food-contact surfaces.

5.2 DAILY CHECKS AND SERVICE

5.2.1 Inspect Fryer and Accessories for Damage- Daily

Look for loose or frayed wires and cords, leaks, foreign material in frypot or inside cabinet, and any other indications that the fryer and accessories are not ready and safe for operation.

5.2.2 Clean Inside and Outside of the Fryer Cabinet – Daily

Clean inside the fryer cabinet with a dry, clean cloth. Wipe all accessible metal surfaces and components to remove accumulated oil and dust.

Clean outside the fryer cabinet with a clean, damp cloth soaked with detergent. Wipe with a clean, damp cloth.

5.2.3 Clean the FilterQuick™ Filtration System Daily

 **WARNING**

Never operate the filter system without oil in the system.

 **WARNING**

Never use the filter pan to transport old oil to the disposal area.

 **WARNING**

Never drain water into the filter pan. Water will damage the filter pump.

Daily clean the filter pan and associated components with a solution of hot water and detergent.

If you notice that the system is pumping slowly or not at all, verify that the filter pan screen is on the bottom of the filter pan, with the paper on top of the screen. Verify that the two O-ring(s) on the fitting at the right front of the filter pan are present and in good condition.

5.2.4 Clean Filter Pan, Detachable Parts and Accessories

Carbonized oil will accumulate on the filter pan and detachable parts and accessories such as baskets, sediment trays, or fish plates.

Wipe the filter pan and all detachable parts and accessories with a clean cloth dampened with a detergent solution (or the parts can be run through a dishwasher). Rinse and thoroughly dry each part. DO NOT use steel wool or abrasive pads to clean these parts. The scratches that result from such scrubbing make subsequent cleanings more difficult.

5.3 WEEKLY CHECKS AND SERVICE

5.3.1 Drain, Clean Frypot and Heating Elements

 **DANGER**

Never operate the appliance with an empty frypot. The frypot must be filled to the fill line with water or oil before energizing the elements. Failure to do so will result in irreparable damage to the elements and may cause a fire.

After the fryer has been in use for a period of time, a hard film of caramelized oil will form on the inside of the frypot. This deposit must be periodically removed to maintain your fryer's efficiency. See the Clean and Filter procedure instructions in the FilterQuick™ controller manual to clean the frypot.

5.3.2 Cleaning the Frypot using a Hot Clean (Boil Out) or Cold Clean (Cold Soak)

During normal usage of your fryer, a deposit of carbonized oil will gradually form on the inside of the frypot. This film should be periodically removed by following the Hot Clean (Boil-Out) or Cold Clean (Cold Soak) procedure. Use the instructions in the FilterQuick™ controller manual to clean the frypot.

 **WARNING**

To prevent injury, ensure adjacent vats that contain oil are OFF and covered prior to performing a Hot Clean (Boil Out) or Cold Clean (Cold Soak).

To clean all frypots simultaneously, dispose of all the oil using the instructions in the FilterQuick™ controller manual. Once the oil is disposed follow the procedures below:

1. Program a product button for 195°F(91°C) and follow the instructions on the detergent container.
2. When the solution is finished simmering, turn off controller.

3. Remove the filter pan and position a METAL container with a sealable cover with a capacity of EIGHT gallons (30 liters) or larger under the fryer drainpipe to drain the boil out solution. The METAL container must be able to withstand the heat of the hot liquids.
4. Drain out the solution using the drain to pan instructions in the FilterQuick™ controller manual and clean the frypot(s) thoroughly.

 **WARNING**

Never leave the fryer unattended during this process. If the solution overflows, press the ON/OFF switch to the OFF position immediately.

 **WARNING**

NEVER drain boil out or cleaning solution into a shortening disposal unit (SDU), a built-in filtration unit, a portable filter unit, or an OQS (Oil Quality Sensor). These units are not intended for this purpose, and will be damaged by the solution and void the warranty.

 **DANGER**

When draining cleaning solution into an appropriate METAL container, make sure the container will hold at least EIGHT gallons (30 liters) or more, otherwise hot/cold liquid could overflow and cause injury.

5. Refill the frypot(s) with clean water. Rinse the frypot(s) twice, drain and dry with a clean towel. Thoroughly remove all water from the frypot and elements before refilling the frypot with oil to the bottom OIL-LEVEL line.
6. Ensure the FilterQuick controller is reset to proper set temperature for cooking or the fryer will remain at 195°F(91°C) temperature.

 **DANGER**

Ensure that the frypot is completely free of water before filling with oil. When the oil is heated to cooking temperature, water in the frypot will cause splattering.

5.3.3 Cleaning the Oil Saddle Reservoir

During normal usage of your fryer, a deposit of carbonized oil will gradually form on the inside of the oil saddle reservoir. It is recommended that the oil saddle be cleaned out according to the store's standard operating procedures. In lieu of standard operating procedures the oil saddle should be cleaned at the completion of a frypot boil out or cold soak when oxidized oil has started to adhere to and accumulate on the inner sides of the saddle. Clean outside the oil saddle reservoir with a clean, damp cloth soaked with detergent. Wipe with a clean, damp cloth.

Follow the procedure below to clean the inside of the oil saddle reservoir.

1. Disconnect the quick disconnect on the bottom of the oil saddle reservoir.
2. Pour the saddle oil into the clean empty frypot.
3. Take the saddle to the sink.
4. Fill with wash temperature water and add a dish detergent cleaning agent. Use the provided nylon brush to scrub the residue from the sides and bottom of the saddle.
5. Flush with water until all detergent residue is removed.
6. Dry thoroughly before remounting to the frypot.
7. Reconnect the quick disconnect.
8. Fill with oil.

5.4 MONTHLY CHECKS AND SERVICE

5.4.1 Check FilterQuick™ Controller Set Point Accuracy

1. Insert a good-grade thermometer or pyrometer probe into the oil, with the end touching the fryer temperature-sensing probe.
2. When the controller displays READY (indicating that the frypot contents are within the cooking range), press the temperature button once to display the temperature of the oil as sensed by the temperature probe and the setpoint. The setpoint is denoted by the temperature with the degree symbol.
3. Note the temperature on the thermometer or pyrometer. Actual temperature and pyrometer readings should be within $\pm 5^{\circ}\text{F}$ (3°C) of each other. If not, contact a Factory Authorized Servicer for assistance.

5.4.2 Pre-filter Maintenance

The pre-filter requires regular maintenance. Every 30 days, or more frequently if the flow of oil slows, remove the cap and clean the attached screen.

1. Wearing protective gloves use the supplied wrench to remove the cap from the pre-filter (**Figure 1**).
2. Use a small brush to clear debris from the attached screen (**Figure 2**).
3. Clean under a water tap and thoroughly dry.
4. Return the cap to the pre-filter housing and tighten.

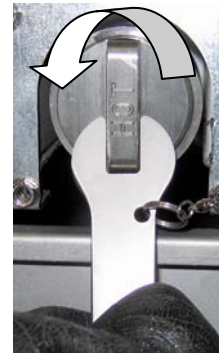

Figure 1



Figure 2



WARNING

DO NOT remove the pre-filter cap when a filter cycle is under way.
DO NOT operate the filter system with the cap removed. Wear protective gloves when handling the cap. The metal and the exposed oil are hot.

5.5 QUARTERLY CHECKS AND SERVICE

5.5.1 Replace the O-rings

Refer to page 4-2 for inspection of O-rings.

5.6 ANNUAL/PERIODIC SYSTEM INSPECTION

This appliance should be inspected and adjusted periodically by qualified service personnel as part of a regular kitchen maintenance program.

Frymaster recommends that this appliance be inspected at least annually by a Factory Authorized Servicer as follows:

5.6.1 Fryer

- Inspect the cabinet inside and out, front and rear for excess oil.
- Verify that the heating element wires are in good condition and that leads have no visible fraying or insulation damage and that they are free of oil.
- Verify that heating elements are in good condition with no carbon/caramelized oil build-up. Inspect the elements for signs of extensive dry-firing.
- Verify that the tilt mechanism is working properly when lifting and lowering elements, and that the element wires are not binding and/or chafing.
- Verify the heating-element amp-draw is within the allowed range as indicated on the appliance's rating plate.
- Verify that the temperature and high-limit probes are properly connected, tightened and functioning properly, and that mounting hardware and probe guards are present and properly installed.
- Verify that component box and contactor box components (i.e. controller, relays, interface boards, transformers, contactors, etc.) are in good condition and free from oil and other debris.
- Verify that component box and contactor box wiring connections are tight and that wiring is in good condition.
- Verify that all safety features (i.e. contactor shields, drain safety switches, reset switches, etc.) are present and functioning properly.
- Verify that the frypot is in good condition and free of leaks and that the frypot insulation is in serviceable condition.
- Verify that all wiring harnesses and connections are tight and in good condition.

5.6.2 1814E with FilterQuick™ Filtration System

- Inspect all oil-return and drain lines for leaks and verify that all connections are tight.
- Inspect the filter pan for leaks and cleanliness. If there is a large accumulation of crumbs in the crumb basket, advise the owner/operator that the crumb basket should be emptied into a fireproof container and cleaned daily.
- Verify that all O-rings and seals (including those on the quick-disconnect fittings) are present and in good condition. Replace O-rings and seals if worn or damaged.
- Check filtration system integrity as follows:
 - Verify that filter pan cover is present and properly installed.
 - With the filter pan empty, place each vat into fill vat from pan selection (see section 1.9.7 of the FilterQuick™ Controller Manual), one at a time. Verify proper functioning of each oil return valve by activating the filter pump using the fill vat from pan selection. Verify that the pump activates and that bubbles appear in the cooking oil of the associated frypot only.
 - Verify that the filter pan is properly prepared for filtering, then drain a frypot of oil heated to a setpoint above 300°F (149°C) (into the filter pan by using the drain to pan selection (see the FilterQuick™ Controller Manual). Now using the fill vat from pan drain pan selection (see the FilterQuick™ Controller Manual), allow all oil to return to the frypot (indicated by bubbles in the cooking oil). Press the up arrow button when all oil is returned. The frypot should have refilled in approximately 5 minutes.

1814 with FILTERQUICK™ SERIES ELECTRIC FRYER

CHAPTER 6: OPERATOR TROUBLESHOOTING

6.1 Introduction

This section provides an easy reference guide to some of the common problems that may occur during the operation of this equipment. The troubleshooting guides that follow are intended to help correct, or at least accurately diagnose, problems with this equipment. Although the chapter covers the most common problems reported, you may encounter problems that are not covered. In such instances, the Frymaster Technical Services staff will make every effort to help you identify and resolve the problem.

When troubleshooting a problem, always use a process of elimination starting with the simplest solution and working through to the most complex. Never overlook the obvious – anyone can forget to plug in a cord or fail to close a valve completely. Most importantly, always try to establish a clear idea of why a problem has occurred. Part of any corrective action involves taking steps to ensure that it doesn't happen again. If a controller malfunctions because of a poor connection, check all other connections, too. If a fuse continues to blow, find out why. Always keep in mind that failure of a small component may often be indicative of potential failure or incorrect functioning of a more important component or system.

Before calling a service agent or the Frymaster HOTLINE (1-800-24-FRYER):

- **Verify that electrical cords are plugged in and that circuit breakers are on.**
- **Verify that frypot drain valves are fully closed.**
- **Have your fryer's model and serial numbers ready to give to the technician assisting you.**

 **DANGER**

Hot oil will cause severe burns. Never attempt to move this appliance when filled with hot oil or to transfer hot oil from one container to another.

 **DANGER**

This equipment should be unplugged when servicing, except when electrical circuit tests are required. Use extreme care when performing such tests.

This appliance may have more than one electrical power supply connection point. Disconnect all power cords before servicing.

Inspection, testing, and repair of electrical components should be performed by an authorized service agent only.

6.2 Troubleshooting

6.2.1 Controller and Heating Problems

Problem	Probable Causes	Corrective Action
No Display on Controller.	A. Controller not turned on. B. No power to the fryer. C. Failed controller or other component. D. Power switch directly under controller is turned off.	A. Press the ON/OFF switch to turn the controller on. B. Verify controller power cord is plugged in and that circuit breaker is not tripped. C. Call your FAS for assistance. D. Turn switch to the on position.
Controller displays IS VAT FULL? YES NO after filtration.	A. Normal after filtering. B. Oil may be in the filter pan.	A. Press ▲ (YES) if the vat is full, otherwise press ▼ (NO). B. Follow controller prompts to clear message. If problem persists, call your FAS for assistance.
Controller displays CHANGE FILTER PAPER?	Daily filter paper change prompt has occurred.	Press ▲ (YES), follow prompts and change the filter paper.
Fryer does not heat.	A. Main power cord not plugged in.	A. Verify that both the main power cord is fully seated in its receptacle, and the circuit breaker is not tripped
	B. Controller has failed.	B. Call your FAS for assistance.
	C. One or more other components have failed.	C. Call your FAS for assistance.
Fryer repeatedly cycles on and off when first started.	Fryer is in melt cycle.	This is normal operation. This will continue until the fryer temperature reaches 180°F (82°C).
Fryer heats until high-limit trips with heat indicator ON.	Temperature probe or controller has failed.	Call your FAS for assistance.
Fryer heats until high-limit trips without heat indicator ON.	Contact or controller has failed	Call your FAS for assistance.

6.2.2 Error Messages and Display Problems

Problem	Probable Causes	Corrective Action
Controller displays LOW TEMP.	Frypot temperature has dropped more than 30°F (17°C) lower than setpoint in idle mode or 45°F (25°C) in cook mode.	This display is normal for a short while if a large batch of frozen product is added to the frypot or if the fryer is not heating properly. If the issue persists call your FAS for assistance.

Problem	Probable Causes	Corrective Action
Controller display is in wrong temperature scale (Fahrenheit or Celsius).	Incorrect display option programmed.	Fryers using the FilterQuick controller can toggle between F° to C° by pressing the ✓ button until Product setup is displayed. Press ► to scroll to Tech Mode and press ✓. Enter 1658. Press the scan button. The controller displays OFF . Turn the controller on to check temperature. If the desired scale is not displayed, repeat.
Controller displays HI TEMP.	Frypot temperature is more than 40 °F (4°C) above set temperature.	Press the power button to turn off fryer and let cool before returning power to fryer. If issue continues call your FAS for assistance.
Controller display shows HOT-HI-1.	Frypot temperature is more than 410°F (210°C) or, in CE countries, 395°F (202°C).	Shut the fryer down immediately and call your FAS for assistance.
Controller displays HIGH LIMIT FAILURE DISCONNECT POWER.	Failed high limit	Shut the fryer down immediately and call your FAS for assistance.
Controller display shows TEMP PROBE FAILURE.	Problem with the temperature measuring circuitry including the probe or damaged controller wiring harness or connector.	Shut the fryer down and call your FAS for assistance.
Controller display shows HEATING FAILURE.	Failed controller, failed interface board, open high-limit thermostat.	Call your FAS for assistance.
Heating indicator is on, but fryer is not heating.	Three phase power cord unplugged or circuit breaker is tripped.	Verify that the main power cord is fully seated in its receptacle, locked into place and that circuit breaker is not tripped. If the problem continues call your FAS for assistance.
Controller displays RECOVERY FAULT/ YES and alarm sounds.	Recovery time exceeded maximum time limit.	Clear error and silence the alarm by pressing the ▲ (YES) button. Maximum recovery time for electric is 1:40. If this error continues call your FAS for assistance.
Controller locks up.	Controller error.	Call your FAS for assistance.
Controller displays SERVICE REQUIRED followed by an error message.	An error has occurred which requires a service technician.	Press the ▲ (YES) button if the issue is fixed or press the ▼ (NO) button to continue cooking and call your FAS for assistance. In some cases, cooking may not be available..

6.2.3 Filtration Problems

Problem	Probable Causes	Corrective Action
Fryer filters after each cook cycle.	Filter prompt setting incorrect.	Change the filter prompt setting.
Filter menu functions won't start or controller displays <i>WAIT FOR FILTER</i> or <i>FILTER BUSY</i>.	<ul style="list-style-type: none"> A. Temperature too low or controller displays OFF. B. Another function is still in process. C. MIB has not cleared checking system. D. Messages or errors on other controllers. E. Filter pan not fully engaged. 	<ul style="list-style-type: none"> A. Ensure fryer is at setpoint before starting; ensure the controller is ON. B. Wait until the previous function ends to start another filtration cycle. C. Wait one minute and try again. D. Clear messages and errors on other controllers. E. Ensure the filter pan is in position and fully inserted into the fryer and "A" is displayed on the MIB board.
Controller displays <i>FLT DYLD OR POL DLYD</i>.	Another function is in process or the filter has been bypassed.	Wait until the previous function ends to start another filtration cycle or select "YES" to "FILTER NOW?" if present on another controller.
Filter pump won't start or pump stops during filtering.	<ul style="list-style-type: none"> A. Power cord is not plugged in or circuit breaker is tripped. B. Pump motor has overheated causing the thermal overload switch to trip. C. Blockage in filter pump. 	<ul style="list-style-type: none"> A. Verify that the power cord is fully plugged in and the circuit breaker is not tripped. B. If the motor is too hot to touch for more than a few seconds, the thermal overload switch has probably tripped. Allow the motor to cool at least 45 minutes then press the Pump Reset Switch (see page 4-5). C. Call your FAS for assistance.
Filter Pump runs, but oil return is very slow.	A. Improperly installed or prepared filter pan components or cold oil.	A. Remove the oil from the filter pan and replace the filter paper, ensuring that the filter screen is in place <i>under</i> the paper. Verify that O-rings are present and in good condition on filter pan connection fitting.
Controller displays <i>OIL IN DRAIN PAN / CONFIRM</i>	Drain valve open or possibility that oil is in drain pan.	Press ▲ (CONFIRM) and follow directions for <i>FILL VAT FROM DRAIN PAN.</i>
Drain valve or return valve stays open.	<ul style="list-style-type: none"> A. AIF board has failed. B. Actuator has failed. 	Call your FAS for assistance.
Controller displays <i>INSERT PAN.</i>	<ul style="list-style-type: none"> A. Filter pan is not fully set into fryer. B. Missing filter pan magnet. C. Defective filter pan switch. 	<ul style="list-style-type: none"> A. Pull filter pan out and fully reinsert into fryer. B. Ensure the filter pan magnet is in place and replace if missing. C. If the filter pan magnet is fully against the switch and controller continues to display <i>INSERT PAN,</i> switch is possibly defective.
Semi-automatic	A. Oil level too low.	A. Ensure oil level is above the top oil level

Problem	Probable Causes	Corrective Action
filtration won't start.	<ul style="list-style-type: none"> B. Check that MIB board is not in manual mode. C. Check to see that the MIB cover is not damaged and depressing the buttons. D. Filter relay has failed. 	<ul style="list-style-type: none"> sensor. B. Ensure MIB board is in "A" automatic mode. Power cycle the fryer. C. Remove and replace cover and see if filtration will start. D. Call your FAS for assistance.
Controller display shows <i>FILTER BUSY</i>.	Another filtration cycle or filter paper change is still in process.	Wait until the previous filtration cycle ends to start another filtration cycle. Change filter paper if prompted.

6.2.4 Basket Lift Problems

Problem	Probable Causes	Corrective Action
Basket lift movement is jerky and/or noisy.	Basket lift rods need lubrication.	Apply a light coating of Lubriplate™ or similar lightweight white grease to the rod and bushings.

6.2.5 Auto Top-Off Problems

Problem	Probable Causes	Corrective Action
Frypots won't top off.	<ul style="list-style-type: none"> A. Crumb build up around sensor. B. Fryer temperature too low. C. Oil is too cold. D. JIB out of oil E. A fryer may be unplugged or fryer with ATO box may not have power. F. Service required error exists G. Lack of cook. 	<ul style="list-style-type: none"> A. Clean crumbs from opening surrounding sensor. B. Fryer temperature must be at setpoint. C. Ensure that the oil in the JIB is above 70°F (21°C). D. Ensure the JIB is not out of oil and supply line is in the JIB. Replace JIB and press the ▲ button when prompted and press and hold the ORANGE reset button for ten (10) seconds to reset top off system. If problem persists call your FAS for assistance. E. Check plugs, breakers and switches. F. Call your FAS for assistance. G. A cook must be complete on the fryer before it enables top off.
One vat doesn't top off.	<ul style="list-style-type: none"> A. Filter error exists. B. Service required error exists C. Solenoid, pump, pin issue, RTD or ATO issue. 	<ul style="list-style-type: none"> A. Clear filter error properly. If problem persists call your FAS for assistance. B. Call your FAS for assistance. C. Call your FAS for assistance.
Controller displays <i>TOPOFF OIL EMPTY / CONFIRM</i>	Top off system out of oil.	Fill top off system with oil and press the ▲ (CONFIRM) button. Once the JIB is replaced or oil saddle filled press and hold the orange reset button for ten (10) seconds to reset top off system.

6.2.6 Error Log Codes (For FilterQuick™ Controller Only)

CODE	ERROR MESSAGE	EXPLANATION
E03	ERROR TEMP PROBE FAILURE	Temp probe reading out of range
E04	HI 2 BAD	High limit reading is out of range.
E05	HOT HI 1	High limit temperature is past more than 410°F (210°C), or in CE countries, 395°F (202°C)
E06	HEATING FAILURE	A component has failed such as controller, interface board, gas valve, ignition module or open-high limit.
E07	ERROR MIB SOFTWARE	Internal MIB software error
E08	ERROR ATO BOARD	ATO board connection lost; ATO board failure
E09	ERROR PUMP NOT FILLING	Dirty paper/pad and it needs changed or it was bypassed; filter pump problem
E10	ERROR DRAIN VALVE NOT OPEN	Drain valve was trying to open and confirmation is missing
E11	ERROR DRAIN VALVE NOT CLOSED	Drain valve was trying to close and confirmation is missing
E12	ERROR RETURN VALVE NOT OPEN	Return valve was trying to open and confirmation is missing
E13	ERROR RETURN VALVE NOT CLOSED	Return valve was trying to close and confirmation is missing
E14	ERROR AIF BOARD	MIB detects AIF missing; AIF board failure
E15	ERROR MIB BOARD	Cooking controller detects MIB connections lost; Check software version on each controller. If versions are missing, check CAN connections between each controller; MIB board failure
E16	ERROR AIF PROBE	AIF RTD reading out of range
E17	ERROR ATO PROBE	ATO RTD reading out of range
E20	INVALID CODE LOCATION	SD card removed during update
E21	FILTER PAPER PROCEDURE ERROR (Change Filter Paper)	25 hour timer has expired or a dirty filter may be causing an incomplete filtration.
E22	OIL IN PAN ERROR	Oil may be present in the filter pan.
E25	RECOVERY FAULT	Recovery time exceeded maximum time limit. Recovery time should not exceed 3:30 for electric.
E27	LOW TEMP ALARM	Oil temperature has dropped 30°F (17°C) lower than setpoint in idle mode or 45°F (25°C) in cook mode. (This message may appear if a product is dropped and the start cook button is not pressed immediately or if too large of cook loads are dropped.)
E28	HIGH TEMP ALARM	Oil temperature has risen 40°F (22.2°C) higher than setpoint. If temperature continues to rise, the high limit will shut the burner off when temperature reaches 425°F (218°C) Non-CE or 395°F (202°C) CE.
E70	OQS TEMP HIGH	Oil temperature is too high for a valid OQS reading. Filter at a temperature between 300°F (149°C) and 375°F (191°C).

CODE	ERROR MESSAGE	EXPLANATION
E71	OQS TEMP LOW	Oil temperature is too low for a valid OQS reading. Filter at a temperature between 300°F (149°C) and 375°F (191°C).
E72	TPM RANGE LOW	The TPM is too low for a valid OQS reading. This may also be seen with fresh new oil. The incorrect oil type may be selected in the setup menu. The sensor may not be calibrated for the oil type. See oil type chart. If issue continues contact a FAS.
E73	TPM RANGE HIGH	The TPM reading is too high for a valid OQS reading. Dispose the oil.
E74	OQS ERROR	The OQS has an internal error. If issue continues contact a FAS.
E75	OQS AIR ERROR	The OQS is detecting air in the oil. Check the O-rings and check/tighten prescreen filter to ensure no air is entering the OQS sensor. If issue continues contact a FAS.
E76	OQS ERROR	The OQS sensor has a communication error. Check connections to the OQS sensor. Power cycle the entire fryer battery. If issue continues contact a FAS.

6.2.7 High-Limit Test Mode

The high-limit test mode is used to test the high limit circuit. The high-limit test will destroy the oil. It should only be performed with old oil. Shut the fryer off and call for service immediately if the temperature reaches 460°F (238°C) without the high-limit tripping and the controller displays **HIGH LIMIT FAILURE** alternating with **DISCONNECT POWER** with an alert tone during testing.

The test is cancelled at any time by turning the fryer off. When the fryer is turned back on, it returns to the operating mode and displays the product.

1. Press and hold the check (✓) button until **MAIN MENU** is displayed followed by **PRODUCT SETUP**.
2. Press the left arrow (◀) button until **TECH MODE** is displayed.
3. Press the check (✓) button.
4. Enter 3000.
5. Press the left arrow (◀) button until **HI LIMIT TEST** is displayed.
6. Press the check (✓) button.

The controller displays **HIGH LIMIT YES/NO**.

7. Press the up arrow (▲) button.
8. The controller displays **PRESS AND HOLD CHECK**.
9. Press and hold the (✓) button to initiate the high-limit test.

The vat begins to heat. The controller displays the actual vat temperature during the test. The fryer continues heating until the high limit trips. Generally this happens once the temperature reaches 423°F to 447°F (217°C to 231°C) for non-CE high limits and 405°F to 426°F (207°C to 219°C) for CE high limits.

Once the high-limit opens the controller displays **HELP HI-2** alternating with the actual temperature (ex. **430F**).

10. Release the (✓) button.

If the high-limit fails, the controller displays **HIGH LIMIT FAILURE** alternating with **DISCONNECT POWER**. If this happens, disconnect power to the fryer and call for service immediately.

The vat stops heating and the controller displays the current temperature setting alternating with the actual temperature (ex. **430F**) until the temperature cools below 400°F (204°C).

11. Press the soft power button to cancel the alarm and go to **OFF**.

12. Follow the procedure to dispose of the oil.

6.2.8 OQS (Oil Quality Sensor) Troubleshooting

Problem	Corrective Action
No TPM results displayed.	Check the following items and perform another OQS filter. <ul style="list-style-type: none">• Ensure the vat is at setpoint temperature.• Inspect the pre-screen filter and ensure it is screwed in tightly.• Inspect the O-rings on the filter pan and ensure they are both present and that they are not missing, cracked or worn. If so replace them.• Ensure the filter paper is not clogged and clean filter paper is used. Did the vat refill the first time for the previous filter? If not change the filter paper.

1814E with FILTERQUICK™ SERIES ELECTRIC FRYER

APPENDIX A: BULK OIL INSTRUCTIONS

A.1.1 Bulk Oil Systems

Bulk oil systems have large oil storage tanks, typically located in the rear of the restaurant, that are connected to a rear manifold on the fryer. Waste oil is pumped from the fryer, via a fitting located on the rear of the fryer labeled DISPOSE (see Figure 1), to the disposal tanks and fresh oil is pumped from the tanks, thru the fitting located on the rear of the fryer labeled FILL, to the fryer (see Figure 2). Connect the bulk oil connections to plug located on the rear of the fryer (see Figure 3). The wiring diagram is located on the next page.

It is imperative that the fryer system be completely power cycled after changing any fresh or waste oil settings.

The 1814E with FilterQuick™ fryers, equipped for use with bulk oil systems, have an onboard fresh oil reservoir that may or may not be supplied by the bulk oil provider. For fryers batteries with two or more vats, remove the cap and insert the standard fitting into the jug with the metal cap resting on the lip of the jug. The oil is pumped in and out of the jug or saddle reservoirs on singles, through the same fitting. (see Figure 4).



Figure 4

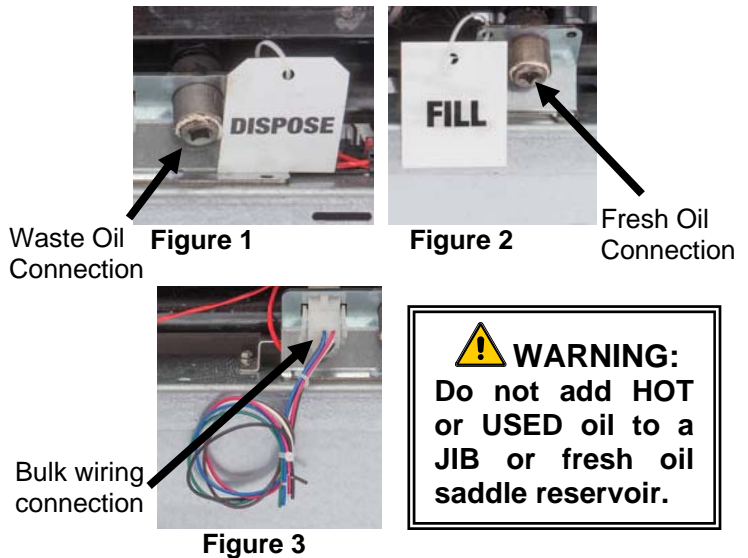

Figure 1
Waste Oil Connection

Figure 2
Fresh Oil Connection

Figure 3
Bulk wiring connection

Figure 3

The momentary switch used to reset the ATO system is also used to fill the jug or saddle in a fresh bulk oil system. After clearing the TOP OFF EMPTY display, pressing and holding the momentary switch, located above the JIB, allows the operator to fill the jug or saddle from the bulk oil storage tank (see Figure 5).

To fill the jug, press and hold the JIB reset button until the jug is full, then release.*

NOTE: Do NOT overfill the jug or saddle.

For instructions on filling the vat from bulk, see the FilterQuick Controller Manual Section 1.9.8.

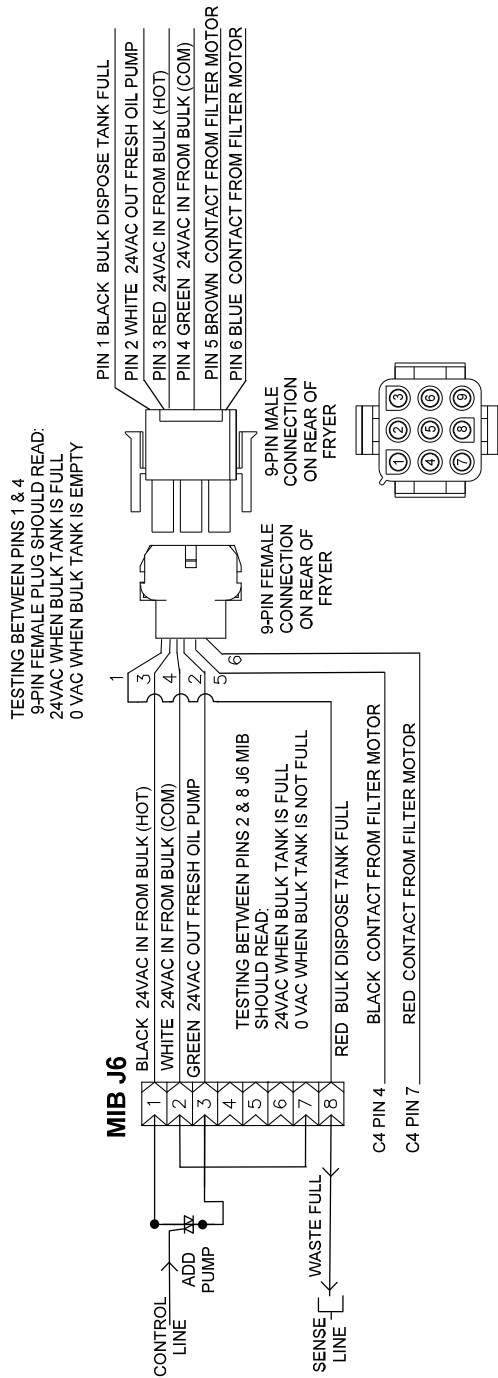

Figure 5

* **NOTE:** It takes approximately twelve seconds from the time the fill JIB button is pressed until the fresh bulk oil pump starts. It may take up to 20 seconds before the level in the JIB begins to rise. Typically it takes approximately three minutes to fill the JIB. It takes approximately two minutes to fill a full vat.

A.1.2 Bulk Oil Wiring

BULK OIL WIRING



⚠ WARNING
 The FilterQuick™ fryer will **ONLY** operate with bulk oil systems that have a three-pole float switch. If the float switch is the older two-pole switch, call the bulk oil provider. These float switches are polarity specific which may short to ground and damage an MIB board.



FRYMASTER
8700 LINE AVENUE, SHREVEPORT, LA 71106-6800

318-865-1711
800-551-8633
844-724-CARE (2273)
WWW.FRYMASTER.COM
EMAIL: SERVICE@FRYMASTER.COM



Every new piece of Manitowoc Foodservice equipment comes with KitchenCare™ and you choose the level of service that meets your operational needs from one restaurant to multiple locations.

StarCare – Warranty & lifetime service, certified OEM parts, global parts inventory, performance audited

ExtraCare – CareCode, 24/7 Support, online/mobile product information

LifeCare – Install & equipment orientation, planned maintenance, KitchenConnect™, MenuConnect

Talk with KitchenCare™ - 1-844-724-CARE - www.mtwkitchencare.com



To learn how Manitowoc Foodservice and its leading brands can equip you, visit our global web site at www.manitowocfoodservice.com, then discover the regional or local resources available to you.

