

PROJECT	QUANTITY	ITEM NO
---------	----------	---------

Pressure Fryers

PFE 500 Electric



PFE 500 electric pressure fryer with Computron™ 8000 control

Henny Penny first introduced commercial pressure frying to the foodservice industry more than 50 years ago. Frying under pressure enables lower cooking temperatures for longer oil life, and faster cooking times to meet peak demand. Pressure also seals in food's natural juices and reduces the amount of oil absorbed into product.

Today, Henny Penny pressure fryers continue to lead the industry in performance, durability and innovation.

The Henny Penny PFE 500 remains one of the most popular and reliable pressure fryers on the market. Operators can choose either low or high wattage immersed heating elements that generate fast

temperature recovery and welcome energy savings.

Henny Penny pressure fryers have a patented lid lock and color-keyed spindle that make it easy to create a perfect pressure seal every time.

A built-in filtration system filters and returns hot frying oil in minutes. No separate pumps and pans, no handling hot oil.

The Computron™ 8000 control features automatic, programmable operation, as well as energy-saving, filtration and cook management functions.

The Computron™ 1000 control offers programmability in a simple, easy to use digital control panel with LED display.

Standard Features

- Patented lid-lock system keeps lid locked until pressure reaches 1 psi
- Color-keyed locking spindle engages pressure seal
- Heavy-duty stainless steel fry pot with 7-year warranty
- High-efficiency heating elements generate fast recovery and energy savings
- Rectangular fry pot design promotes turbulence for even cooking
- Cold zone below heating elements helps extend oil life
- High-limit temperature protection
- Built-in filtration system
- Cast aluminum alloy lid is strong but light for easy handling
- Channel under lid directs condensation away from pot when lid is up
- Raised edge on deck reduces spills
- Stainless steel construction for easy-cleaning and long life
- Narrow footprint saves floor space and cookline frontage
- 4 heavy-duty casters, 2 locking
- Computron™ 8000 control (additional charge)
 - 10 programmable cook cycles
 - Melt mode
 - Idle mode
 - Clean-out mode
 - Water detection alert
 - Load compensation
 - Proportional control
 - Optional filter prompt and customizable filter tracking
 - 16-character digital display with multiple language settings
- Computron™ 1000 control
 - Programmable
 - LED Time/Temp display
 - Simple UP/DOWN arrows

Accessories shipped with unit

Max filter screen with standard filter media (2 PHT filter envelopes)

Accessories and options available separately

- Direct Connect shortening disposal
- 4-tiered basket
- Locking basket handle
- Full-size basket and handle
- Crumb pan and handle
- Filter rinse hose attachment
- Filter pan dolly
- Supersorb filter pad

<input type="checkbox"/> APPROVED	<input type="checkbox"/> APPROVED AS NOTED	<input type="checkbox"/> RESUBMIT
AUTHORIZED SIGNATURE		DATE

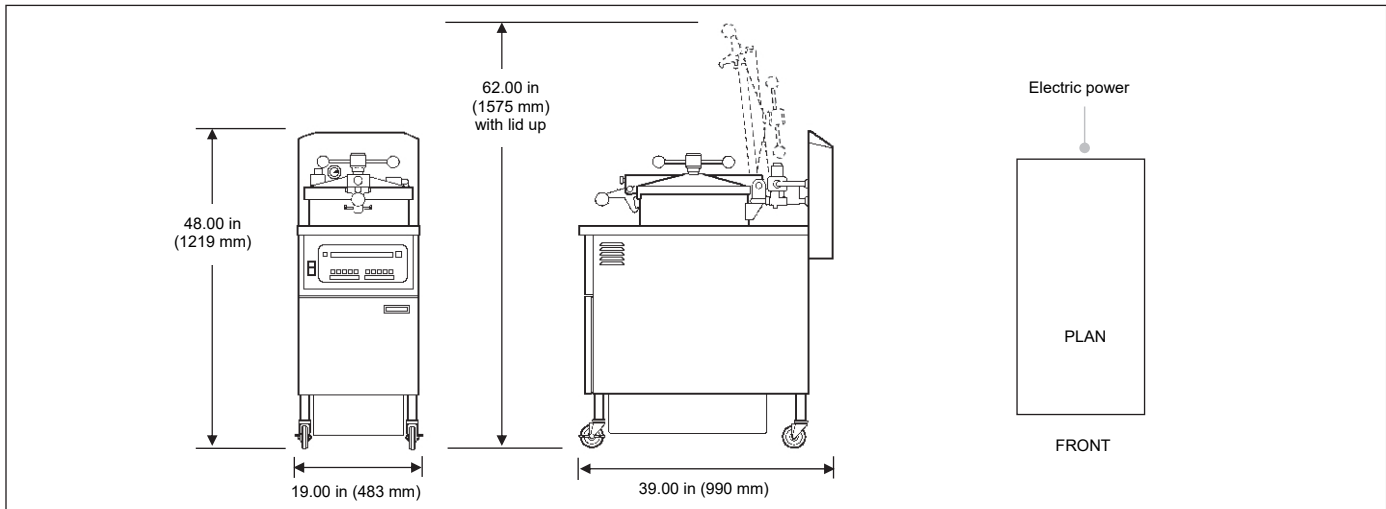

Pressure Fryers

PFE 500 Electric

Dimensions

Height	48.00 in	(1219 mm)	top of stack
Height	62.00 in	(1575 mm)	with lid up
Width	19.00 in	(483 mm)	
Depth	39.00 in	(990 mm)	

Crated

Length	45 in	(1143 mm)
Depth	22 in	(559 mm)
Height	56 in	(1420 mm)
Volume	32 ft ³	(0.91 m ³)
Weight	340 lb	(154 kg)

Required clearances

Top	14 in	(356 mm)	lid up
Sides	6 in	(152 mm)	air flow
Back	6 in	(152 mm)	air flow
Front	30 in	(762 mm)	remove filter pan

Pressure

Operating pressure	12.0 psi
Safety valve setting	14.5 psi

Heating

- 3 immersed elements
- 3.75 kW each/11.25 kW total
 - 4.50 kW each/13.50 kW total

Capacity

Product	14 lb (6.4 kg)
Oil	48 lb or 25 L

Bidding specifications

Provide Henny Penny model PFE 500 electric pressure fryer, 14 lb (6.4 kg) capacity per load, and built-in filtration system.

Unit shall incorporate:

- Computron™1000 simple digital control OR Computron™ 8000 control system (additional charge) with programmable or manual operation, LED digital display, idle and melt modes, load compensation, filtration tracking and 7-day history
- Fry pot of heavy duty stainless steel with 7-year warranty
- Color-keyed locking spindle and lid-lock system to seal and create and maintain 12 psi pressure in cooking chamber
- 4 heavy-duty casters, 2 locking
- Starter kit with choice of filter media

Electrical

Volts	Phase	Hertz	11.25 kW Amps	13.50 kW Amps	Wire*
190-208	1	50 or 60	54.0	65.0	2+G
190-208	3	50 or 60	32.0	38.0	3+G
208	1	60	54.0	65.0	2+G
208	3	60	32.0	38.0	3+G
220-240	1	50 or 60	47.0	58.0	2+G
220-240	3	50 or 60	27.0	33.0	3+G
220/380	3	50 or 60	17.1	20.5	4+G
240/415	3	50 or 60	15.6	18.8	4+G
380-415	3	50	17.1	18.8	3NG
480	3	60	14.0	16.0	3+G

Optional power cord and plug can be supplied for 3 phase 208 V and 220-240 V units only

NEMA 15-50P

Laboratory certifications

*Power cord and plug must be installed on site by a qualified electrician.

Continuing product improvement may subject specifications to change without notice.

24 Hour Technical Support:
Henny Penny Technical Service
800 417.8405
technicalservices@hennypenny.com

Henny Penny Corporation
PO Box 60 Eaton OH 45320 USA

+1 937 456.8400 800 417.8417
+1 937 456.8434 Fax 800 417.8434 Fax
www.hennypenny.com

HENNY PENNY
Engineered to Last