

Gelatoshow is the first gelato cabinet featuring all transparent structure and containers that revolutionizes the ice-cream display providing a 3D visibility. It is fitted with the front lighting, as standard equipment, that exalts further the ice-cream display. Ventilated refrigeration with horizontal finned evaporator and double airflow for a perfect uniformity of temperature. Automatic reverse defrosting cycle. One piece body with ecological polyurethane insulation (HCFC & HFC free), foamed with CO₂ - 60 mm thick. Display base and rear side panel in carbon steel painted with epoxy powder. Service top in bright stainless steel, rear panel in painted sheet with epoxy powder, external base in painted sheet. Tempered front glass with tilt-down opening. Methacrylate pull-out side glasses for an easier cleaning. Profile, complete light heading in silver-colored anodized aluminium, LED lighting. Operator side closure with hidden sliding glass with counterpoises for an easier handling. Main structure and basement in carbon steel painted with epoxy powder, adjustable feet. Control board on the operator side, electronic board and digital thermometer inside the tank, temperature control set at -20/+ 2 °C and HACCP control. Front and side panels insulated with anti-fog ventilation system and powder painting with anti-scratch treatment.

Gelatoshow rivoluziona il modo di esporre il gelato in quanto è la prima vetrina con frontale, fianchi e vaschette trasparenti che consentono di mostrare il prodotto in tre dimensioni. Illuminazione frontale di serie per dare ulteriore risalto al gelato. Refrigerazione ventilata con evaporatore alettato orizzontale e doppia mandata d'aria per una perfetta equalizzazione delle temperature, sbrinatorio automatico ad inversione di ciclo. Scocca monolitica coibentata in poliuretano ecologico (HCFC & HFC free) espanso a CO₂ con spessore mm 60. Piano espositivo e fianco lato operatore in acciaio al carbonio verniciato a polvere epossidica, piano di servizio in acciaio inox finitura lucida, fondo esterno vasca in lamiera preverniciata. Vetro frontale in cristallo temprato con apertura verso il basso. Vetri laterali camera. Profilo e plafoniera alluminio colore argento, illuminazione LED. Chiusura lato operatore con vetro a scorrimento verticale a scomparsa con contrappesi per facilitare la movimentazione. Struttura portante e basamento in acciaio al carbonio verniciato a polvere epossidica, con piedini regolabili. Quadro comandi posizionato su lato operatore con centralina elettronica e termometro digitale in vasca, set di regolazione temperatura predisposto per -20/+ 2 °C e controllo HACCP. Pannello frontale e fianchi estetici coibentati con sistema di ventilazione anticondensa e verniciatura a polvere con trattamento antigraffio.



ENERGY SAVING
LED + EC Fan motor



INSTALLATION
Plug-in / Remote unit



TEMPERATURE
-20/+2°C



DEFROST
Reverse cycle



CLIMATIC CLASS
4





Gelatoshow **Catalog** - Catalogo









Model Modello	Code Codice	Condensing unit included Unità condensatrice a bordo			Condensing unit excluded Unità condensatrice esclusa	Remote condensing unit included up to 20 meters Unità condensatrice remota compresa fino a 20 metri	
		R404A Air Aria	Water Acqua	Air-Water Aria-Acqua		Air Aria	Air-Water Aria-Acqua
RV	120	SHG0012001L	*****	*****	*****	*****	*****
	155	SHG0015501L	*****	*****	*****	*****	*****
	170	SHG0017001L	*****	*****	*****	*****	*****
	190	SHG0019001L	*****	*****	*****	*****	*****
	220	SHG0022001L	*****	*****	*****	*****	*****

Gelatoshow **Technical features** - Caratteristiche tecniche

	120	155	170
External dimensions (LxDxH) Dimensioni esterne [LxPxH]	1110 x 1209 x 1378 mm	1440 x 1209 x 1378 mm	1605 x 1209 x 1378 mm
Capacity (gross/net) Capacità [lorda/netta]			
Net weight Peso netto	342 kg	404 kg	435 kg
Refrigeration Refrigerazione	Ventilated - Ventilata		
Refrigerant Refrigerante	R404A		
Climatic class Classe climatica	4		
Operating conditions Condizioni ambientali	30 °C / 55 %RH		
Cabinet capacity range Temperatura di regolazione	-20/+2 °C		
Product temperature Temperatura prodotto	-16/-14 °C		
Compressor (type) Compressore (tipologia)	1 Semi-Hermetic - 1 Semi-Ermetico		
Defrost Sbrinamento	Reverse cycle - Inversione cycle		
Power supply Alimentazione	400 V / 3 Ph / 50 Hz		
Electrical input (standard) Assorbimento elettrico	2010 W / 4,2 A	2800 W / 7 A	3200 W / 8,7 A
Electrical input (defrost) Assorbimento elettrico	3530 W / 9 A	4200 W / 10 A	4670 W / 11,4 A

APP (Advanced Product Promotion) APP (Visualizzatore digitale messaggi promozionali)	Front glass riser Deflettore anteriore	Polycarbonate containers Vaschette in policarbonato	
		 5 Lt 360 x 165 x 120h 9001991000006 ***** each/cad.	 5 Lt 360 x 250 x 80h 9001991000007 ***** each/cad.
*****	*****	12	8
	*****	16	10
	*****	18	12
	*****	20	12
	*****	24	16

Available Colours - Colori disponibili

Beige Perlato RAL 1035	Arancio Perlato RAL 2013	Giallo Metalliz. 445	Alluminio Brillante RAL 9006	Grigio Metalliz. 440	Azzurro Metalliz. 407 BL2014	Blu Notte Perlato RAL 5026	Rosso Titanite 567	Blu Chiaro Metalliz. 407 BT5014
								

190	220
1770 x 1209 x 1378 mm	2100 x 1209 x 1378 mm
470 kg	526 kg
Ventilated - Ventilata	
R404A	
4	
30 °C / 55 %RH	
-20/+2 °C	
-16/-14 °C	
1 Semi-Hermetic - 1 Semi-Ermetico	
Reverse cycle - Inversione cycle	
400 V / 3 Ph / 50 Hz	
4000 W / 11,5 A	4520 W / 12,5 A
5000 W / 12,5 A	5620 W / 13,9 A

Section - Sezioni

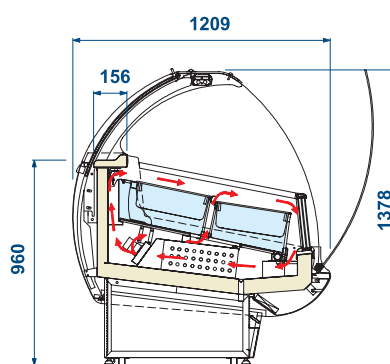

Gelatoshow **Optionals** - Accessori

Item	Accessorio	Mod.	Code	Price
Grey cone holder	Portaconi completo grigio	-	9001390900810	*****
Cone holder complete of toppings container	Portaconi completo di vaschette portagranelle	-	9001390900800	*****
Consolle scoop washer with water tap RIGHT	Consolle lavaporzionario con rubinetto DX	-	9001920000265	*****
Consolle scoop washer with shower selfrolling RIGHT	Consolle lavaporzionario con doccetta avvolgitubo DX	-	9001920000266	*****
Flavours tags kit for container [n.12]	Kit segnagusti per vaschette [n.12]	-	9004400000001	*****
Metacrilate ice-cream spoon [each]	Paletta in metacrilato [cadauna]	-	9004400000000	*****
Ice lolly container - 250 x 360 x 43h [each]	Vaschetta portaghiaccioli - 250 x 360 x 43h [cadauna]	-	9001990000014	*****
Wheel Kit for easy handling	Kit ruote movimentazione vetrina	-	9001923050000	*****