

CLEANING INSTRUCTIONS

SOUL

Caution! For a correct cleaning process please follow the instructions below. Make sure machine is unplugged from electrical current.

1

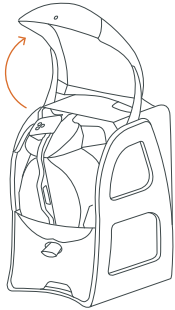

Raise the **Front door** as far as it will go.

2



Remove the **Waste container** to empty the peel.

3

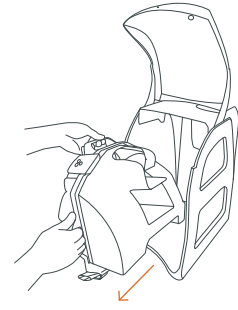

Pull the **Juice extraction unit** out, sliding it along the guides until it is fully released.

4

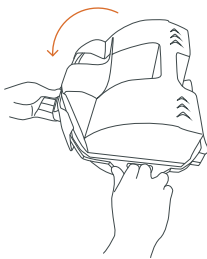

Rest the **Juice extraction unit** on a flat surface to dismantle it, resting the left-hand side and leaving the fasteners on that same side.

5

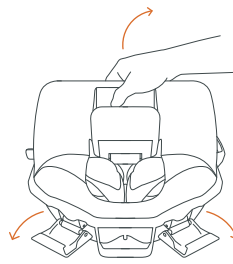

Open the fasteners to remove the **Cover** for cleaning, pulling upwards as indicated in the drawing, taking care with the flanges.

6

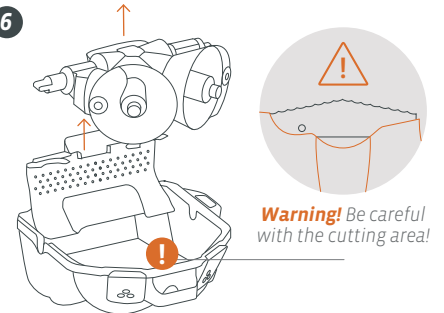

Warning! Be careful with the cutting area!

Take out the **Filter** using the adhesive flange. Then remove the entire pressing unit and shafts, pulling the grip upwards from its central support.

7

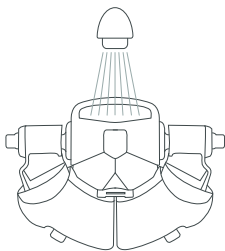

Rinse the parts with water using your hand or a sponge to remove the remains of pulp.

8

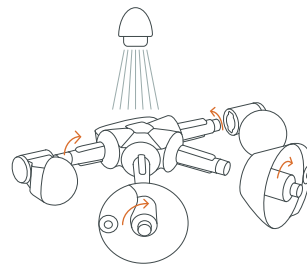

To remove the **Pressing units** for in-depth cleaning of their parts, turn the **Fasteners** of the pressing units a quarter of a turn.

9

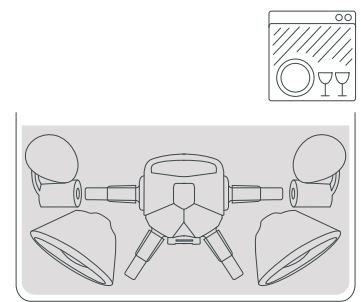

You can also put the parts in the dishwasher. You must use the soap, salt and brightener correctly, so that the parts remain shiny.

10

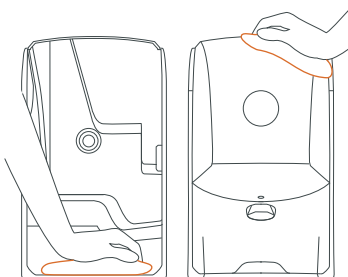

You can clean the inside and outside of the machine with a damp cloth or a soapy sponge – with neutral soap. Then, rinse and dry.

Do not use a rough cloth as this may damage the machine surface.



Zumex recommends using CITROCLEAN to improve the cleaning results of the machine, especially to eliminate waxes.

Important:

Do not pull the soft ejectors from the **Filter**. (6)

The **Shaft unit** with its central support is an indivisible unit. You must not remove it. (8)

To assemble the machine repeat the process in reverse and ready to work.