

Millennium LX /ST/JX

Gelato cabinets with ventilated refrigeration, finned evaporator and automatic reverse defrosting cycle. One piece body with ecological polyurethane insulation (HCFC & HFC free), foamed with CO₂ 60 mm thick. Display base and service top in bright stainless steel, rear panel in plastified sheet, external base in painted sheet. Upper structure with lateral profiles in carbon steel painted with epoxy powder, black colour. External stratified side panels. Tempered glass structure. Front pyrolytic lift-up curved anti-fog glass with hydraulic pistons. Profile, complete light heading in silver-colored anodized aluminium, neon lighting. Operator side closure with self-rolling curtain. Main structure and basement in carbon steel painted with epoxy powder, adjustable feet. Control board on the operator side with electronic board and digital thermometer inside the tank, temperature control set at -20/+ 2 °C. Side panels in compact grade standard and anti-scratch lacquering.

Vetrine Gelato a refrigerazione ventilata con evaporatore alettato e sbrinamento automatico ad inversione di ciclo. Scocca monolitica coibentata in poliuretano ecologico (HCFC & HFC free) espanso a CO₂ con spessore mm 60. Piano espositivo e piano di servizio in acciaio inox finitura lucida, pannello lato operatore in lamiera plastificata, fondo esterno vasca in lamiera preverniciata. Fianchi esterni estetici in stratificato. Sovrastruttura con montanti laterali in acciaio al carbonio verniciati a polvere epossidica, colore nero. Vetri in cristallo temprato. Vetro frontale curvo pirolitico anti-condensa, con apertura verso l'alto servoassistita. Profilo plafoniera in alluminio anodizzato colore argento, illuminazione Led. Chiusura lato operatore con tendina autoavvolgente. Struttura e basamento in acciaio al carbonio verniciato a polvere epossidica, con piedini regolabili. Quadro comandi posizionato su lato operatore con centralina elettronica e termometro digitale in vasca, set di regolazione della temperatura predisposto per -20/+ 2 °C.



ENERGY SAVING
Led + EC Fan motor



INSTALLATION
Plug-in / Remote unit



TEMPERATURE
-20/+2°C



DEFROST
Reverse cycle



CLIMATIC CLASS
7



Millennium LX con pannello AD1







Millennium ST con pannello AD3



Millennium JX con pannello AD6 Lemon

Millennium LX/ST/JX Catalog - Catalogo

Model Modello	Code Codice	Condensing unit included Unità condensatrice a bordo			Condensing unit excluded Unità condensatrice esclusa	Remote condensing unit included (up to 20 meters) Unità condensatrice remota compresa (fino a 20 metri)	
		R404A Air Aria	Water Acqua	Air-Water Aria-Acqua		Air Aria	Air-Water Aria-Acqua
12	LX	MIL0001207L					
	ST	MIL00012STL	*****	*****	*****	*****	*****
	JX	MIL00012JXL					
16	LX	MIL0001607L					
	ST	MIL00016STL	*****	*****	*****	*****	*****
	JX	MIL00016JXL					
18	LX	MIL0001807L					
	ST	MIL00018STL	*****	*****	*****	*****	*****
	JX	MIL00018JXL					
20	LX	MIL0002007L					
	ST	MIL00020STL	*****	*****	*****	*****	*****
	JX	MIL00020JXL					
24	LX	MIL0002407L					
	ST	MIL00024STL	*****	*****	*****	*****	*****
	JX	MIL00024JXL					
12+12	LX	MIL0121207L					
	ST	MIL01212STL	*****	*****	*****	*****	*****
	JX	MIL01212JXL					

Slider Scorrevoli	Stainless steel containers Vaschette inox				
					
	5 Lt 360 x 165 x 120h 9001990000005 ***** each/cad.	7 Lt 360 x 165 x 150h 9001990000007 ***** each/cad.	5 Lt 360 x 250 x 80h 9001990000017 ***** each/cad.	10 Lt 360 x 250 x 120h 9001990000010 ***** each/cad.	12 Lt 360 x 250 x 150h 9001990000012 ***** each/cad.
*****	12	12	8	8	8
*****	16	16	10 +KitSup ***** 9001922050001	10 +KitSup ***** 9001922050001	10 +KitSup ***** 9001922050001
*****	18	18	12 +KitSup ***** 9001922050002	12 +KitSup ***** 9001922050002	12 +KitSup ***** 9001922050002
*****	20	20	12 +KitSup ***** 9001922050003	12 +KitSup ***** 9001922050003	12 +KitSup ***** 9001922050003
*****	24	24	16 +KitSup ***** 9001922050004	16 +KitSup ***** 9001922050004	16 +KitSup ***** 9001922050004
*****	12 + [12]	12 + [12]	8 + [8]	8 + [8]	8 + [8]

Millennium LX/ST/JX **Technical features** - Caratteristiche tecniche

Section - Sezioni

LX

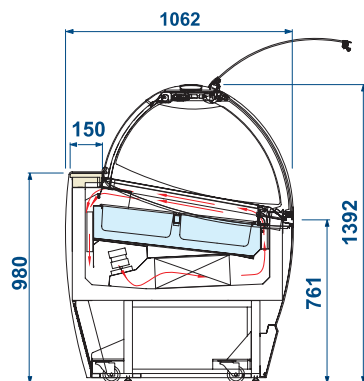

ST

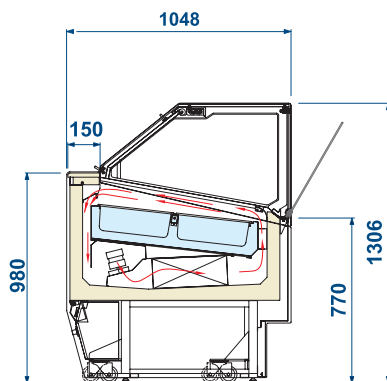

JX

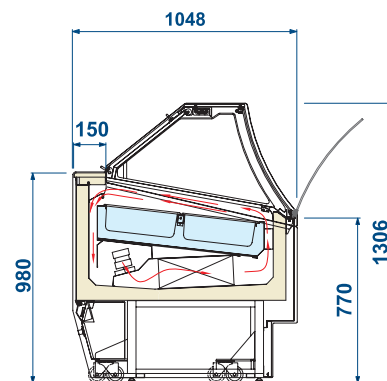















		12	16	18
External dimensions [LxDxH] Dimensioni esterne [LxPxH]	LX	1148 x 1062 x 1392 mm	1508 x 1062 x 1392 mm	1678 x 1062 x 1392 mm
	ST	1143 x 1048 x 1306 mm	1503 x 1048 x 1306 mm	1673 x 1048 x 1306 mm
	JX	1143 x 1048 x 1306 mm	1503 x 1048 x 1306 mm	1673 x 1048 x 1306 mm
Capacity [gross/net] Capacità [lorda/netta]		630 / 118 lt	870 / 160 lt	970 / 181 lt
Net weight Peso netto		235 kg	303 kg	330 kg
Refrigeration Refrigerazione		Ventilated - Ventilata		
Refrigerant Refrigerante		R404A [1] - R744 [2] - R290 [3]		
Climatic class Classe climatica		7		
Operating conditions Condizioni ambientali		35 °C / 75 %RH		
Cabinet capacity range Temperatura di regolazione		-20/+2 °C		
Product temperature Temperatura prodotto		-16/-14 °C		
Compressor [type] Compressore [tipologia]		1 Hermetic - 1 Ermetico	2 Hermetic - 2 Ermetico	
Defrost Sbrinamento		Reverse cycle - Inversione ciclo [1] - Hot gas - Gas caldo [2-3]		
Power supply Alimentazione		230 V / 1 Ph / 50 Hz		
Electrical input [standard] Assorbimento elettrico		[1] 1650 W / 7,8 A	[1] 1950 W / 8,8 A	[1] 2000 W / 8,9 A [2] 2500 W / 12 A
Electrical input [defrost] Assorbimento elettrico		[1] 3500 W / 15,6 A	[1] 3990 W / 18 A	[1] 4020 W / 18 A [2] 2200 W / 13 A









20	24	12+12	
1848 x 1062 x 1392 mm	2188 x 1062 x 1392 mm	2188 x 1062 x 1392 mm	
1843 x 1048 x 1306 mm	2183 x 1048 x 1306 mm	2183 x 1048 x 1306 mm	
1843 x 1048 x 1306 mm	2183 x 1048 x 1306 mm	2183 x 1048 x 1306 mm	
1080 / 201 lt	1300 / 241 lt	1300 / 241 lt	
348 kg	437 kg	470 kg	
Ventilated - Ventilata			
R404A ^[1] - R744 ^[2] - R290 ^[3]			
7			
35 °C / 75 %RH			
-20/+2 °C			
-16/-14 °C			
2 Hermetic - 2 Ermetico			
Reverse cycle - Inversione ciclo ^[1] - Hot gas - Gas caldo ^[2-3]			
230 V / 1 Ph / 50 Hz			
^[1] 2400 W / 11 A	^[1] 3140 W / 15 A	^[3] 1750 W / 9,1 A	^[1] 2850 W / 14 A
^[1] 5000 W / 20,2 A	^[1] 5050 W / 20,5 A	^[3] 3100 W / 15 A	^[1] 5900 W / 25 A

Millennium LX/ST/JX **Colours - Colori**

Available Colours - Colori disponibili

Model Modello	Side Panel Fianco laterale	Front panel Pannello frontale							
		Laquered finishes / Finiture laccate							
	Grigio E_Z065	Grigio E_Z065	Blu Cielo RAL 5005	Bianco RAL 9003	Orange RAL 2001	Beige Perlato RAL 1035	Rosso RAL 3020	Lemon RAL 1032	Alluminio RAL 9006
									
12					*****				
16					*****				
18					*****				
20					*****				
24					*****				
12+12					*****				

Model Modello	Front panel Pannello frontale					
	Laquered finishes / Finiture laccate					
	PM_02 Grigio E_Z 065	PM_02 Orange RAL 2001	PM_02 Blu cielo RAL 5005	PM_02 Bianco RAL 9003	PM_02 Lemon RAL 1032	PM_02 Rosso RAL 3020
						
12						*****
16						*****
18						*****
20						*****
24						*****
12+12						*****

Model Modello	Front panel Pannello frontale							
	With sticker / Con adesivo							
	PM_AD1	PM_AD2	PM_AD3	PM_AD5 Orange	PM_AD6 Lemon	Millefiori Orange	Millefiori Bianco	Millefiori Black
								
12								*****
16								*****
18								*****
20								*****
24								*****
12+12								*****

Millennium LX/ST/JX **Optionals** - Elementi opzionali



Item	Accessorio	Mod.	Code	Price
Cone holder	Portaconi completo	-	9001390900700	*****
Scoop washer water tap, consolle RX	Lavaporzionatore con rubinetto e consolle portaoggetti DX	-	9001920000001	*****
Scoop washer water tap, consolle LX	Lavaporzionatore con rubinetto e consolle portaoggetti SX	-	9001920000000	*****
Stainless steel tray V1 2x2 lt 5- 330 x 690 x 100h	Vassoio inox V1 2x2 lt 5 - 330 x 690 x 100h	-	9001990100010	*****
Stainless steel tray V2 2x3 lt 5- 495 x 690 x 100h	Vassoio inox V2 2x3 lt 5- 495 x 690 x 100h	-	9001990100015	*****
Wheel kit	Kit ruote	-	9001922050040	*****

Millennium LX/ST/JX **Customizable area** - Aree personalizzabili



Mod. 12	1123 x 460 mm
Mod. 16	1483 x 460 mm
Mod. 18	1653 x 460 mm
Mod.20	1823 x 460 mm
Mod. 24	2163 x 460 mm
Mod. 12+12	2163 x 460 mm