

Pastryshow is a real stage that perfectly enhances food appeal of the products displayed thanks to the completely transparent glass structure. This cabinet is complete of ventilated refrigeration with finned evaporator. One piece body with ecological polyurethane insulation [HCFC & HFC free] foamed with CO<sub>2</sub> - 50 mm thick. Inclined display base in bright stainless steel. Operator side in carbon steel painted with epoxy powder, service top in bright stainless steel and external base in painted sheet. Front glass with tilt-down opening. Glass top with lighting canopy in silver-colored anodized aluminium, LED lighting. Three shelves with electronic neon, lighting canopies in silver-colored anodized aluminium. Main structure and basement in carbon steel painted with epoxy powder, adjustable feet. Control board on the operator side, electronic board with HACCP control and digital thermometer inside the tank. Front panel with anti-fog system, side panels powder painted with anti-scratch treatment.

Pastryshow è un vero e proprio palcoscenico per la pasticceria grazie alla totale trasparenza del castello vetri che valorizza ed esalta alla perfezione il food appeal dei prodotti esposti. Vetrine a refrigerazione ventilata con evaporatore alettato. Scocca monolitica dentata in poliuretano ecologico [HCFC & HFC free] espanso a CO<sub>2</sub> con spessore mm 60. Piano espositivo inclinato realizzato in acciaio inox finitura lucida. Fianco lato operatore in acciaio al carbonio verniciato a polvere epossidica, piano di servizio in acciaio inox finitura lucida, fondo esterno vasca in lamiera preverniciata. Vetro frontale in cristallo temprato con apertura verso il basso. Top in vetro con plafoniera in alluminio anodizzato colore argento, illuminazione LED. Tre mensole con illuminazione elettronica a LED e plafoniere in alluminio anodizzato colore argento. Struttura portante e basamento in acciaio al carbonio verniciato a polvere epossidica, con piedini regolabili. Quadro comandi posizionato su lato operatore, centralina elettronica con controllo HACCP e termometro digitale in vasca. Pannello frontale con sistema di ventilazione anticondensa, fianchi estetici coibentati e verniciati a polvere con trattamento antigraffio.



**ENERGY SAVING**  
LED + EC Fan motor



**INSTALLATION**  
Plug-in / Remote unit



**TEMPERATURE**  
+1/+10 °C



**DOORS SYSTEM**  
Glass Lids



**DEFROST**  
Off cycle



**CLIMATIC CLASS**  
3











## Pastryshow **Catalog** - Catalogo

Model Modello	Code Codice	Condensing unit included Unità condensatrice a bordo	Condensing unit not included Senza unità condensatrice a bordo	Remote condensing unit included (up to 35 meters) Unità condensatrice remota compresa (fino a 35 metri)	Air / Aria	Air+Water / Aria+Acqua
		<b>R404A</b> Air / Aria				
RV	<b>120</b>	PSH0361201L	*****	*****	*****	*****
	<b>170</b>	PSH0361701L	*****	*****	*****	*****
	<b>220</b>	PSH03B2201L	*****	*****	*****	*****

## Pastryshow **Technical features** - Caratteristiche tecniche

	<b>120</b>	<b>170</b>	<b>220</b>
<b>External dimensions [LxDxH]</b> Dimensioni esterne [LxPxH]	1110 x 1209 x 1378 mm	1605 x 1209 x 1378 mm	2100 x 1209 x 1378 mm
<b>Capacity [gross/net]</b> Capacità [lorda/netta]	804 / 267 lt	1183 / 393 lt	1562 / 518 lt
<b>Net weight</b> Peso netto	270 kg	345 kg	415 kg
<b>Refrigeration</b> Refrigerazione	Ventilated - Ventilata		
<b>Refrigerant</b> Refrigerante	R404A		
<b>Climatic class</b> Classe climatica	3		
<b>Operating conditions</b> Condizioni ambientali	25 °C / 60 %RH		
<b>Product temperature</b> Temperatura prodotto	+1 / +10 °C		
<b>Compressor [type]</b> Compressore [tipologia]	1 Hermetic - 1 Ermetico		
<b>Defrost</b> Sbrinamento	Off cycle - Fermata compressore		
<b>Power supply</b> Alimentazione	230 V / 1 Ph / 50 Hz		
<b>Electrical input [standard]</b> Assorbimento elettrico	1320 W / 8 A	1600 W / 10 A	2560 W / 12,5 A
<b>Electrical input [defrost]</b> Assorbimento elettrico	650 W / 4,2 A	800 W / 6 A	1280 W / 8,2 A

## Available Colours - Colori disponibili

Beige perlato RAL 1035	Arancio perlato RAL 2013	Giallo metallizzato 445	Alluminio brillante RAL 9006	Grigio metallizzato 440	Azzurro metallizzato 407 BL 2014	Blu notte perlato RAL 5026	Rosso Titanite 567	Blu chiaro metallizzato 433 BT 5014
								

## Section - Sezioni

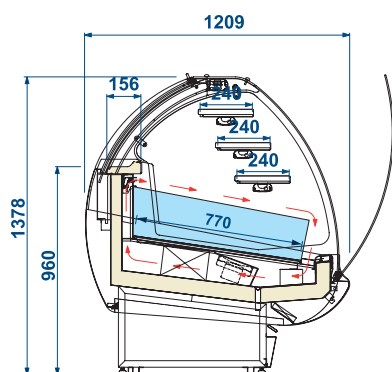

## Pastryshow **Optionals** - Elementi opzionali

---

<b>Item</b>	<b>Accessorio</b>	<b>Mod.</b>	<b>Code</b>	<b>Price</b>
Wheel kit	Kit ruote	-	9001923050000	*****